

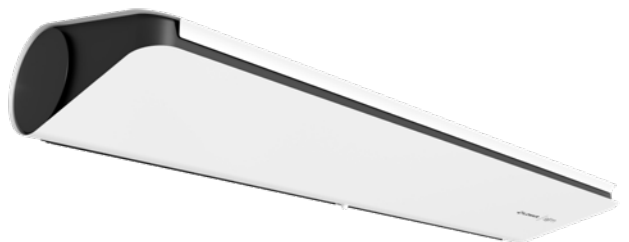

AIR CURTAINS AND AIR CURTAIN-FAN HEATER UNITS

Air curtains ELiS and Slim



AIR CURTAINS AND AIR CURTAIN-FAN HEATER UNITS

COMPARE ELiS SOLUTIONS

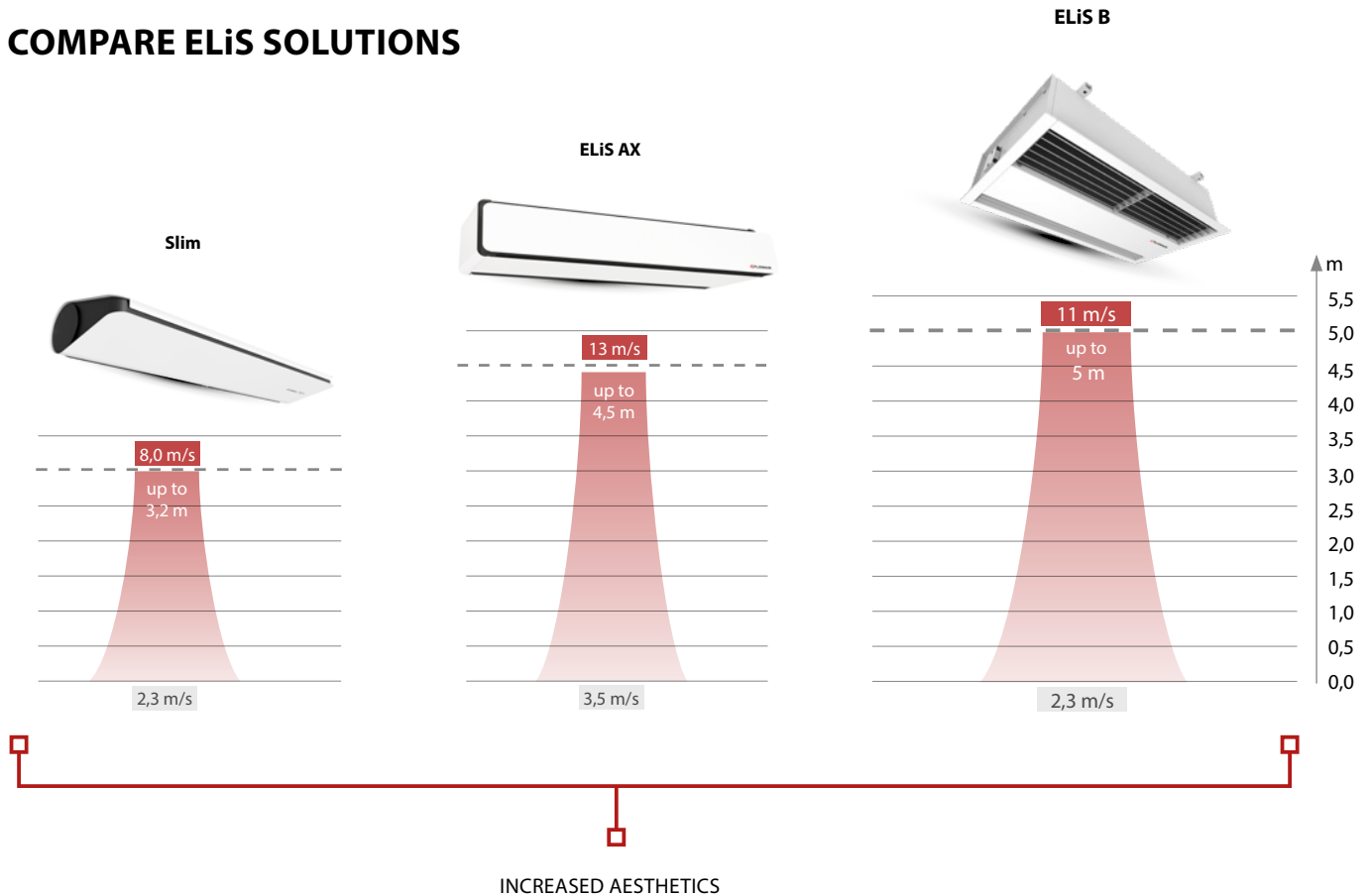

TECHNICAL DATA

	Slim	ELiS AX	ELiS B
Version	W/E/N	W	W/E/N
Height of installation	do 3,2 m	do 4,5 m	do 5 m
Air flow	750–3000 m ³ /h	800–6100 m ³ /h	2000–6600 m ³ /h
Acoustic pressure level	33,5–58 dB(A)	41–65 dB(A)	55–66 dB(A)
BMS	via DRV Slim	in standard	in standard

N – without heating elements

W – water heat exchanger

E – electric heaters

■ – speed limit at the floor level

■ – outlet air velocity

APPLICATION



- shops
- shopping centers
- petrol stations



- commercial buildings
- shopping centers/malls
- logistics centers



- hotels
- offices
- shopping centers

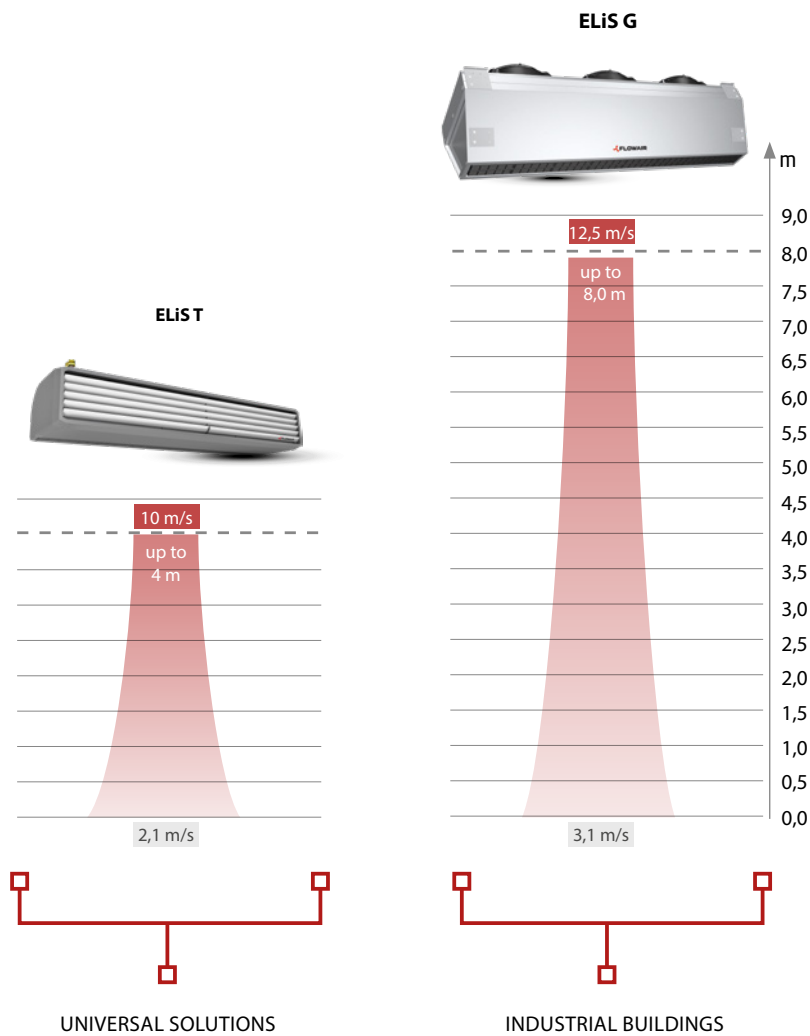

TECHNICAL DATA

	ELiS T	ELiS G
Version	W/E/N	W/E/N
Height of installation	do 4 m	do 8 m
Air flow	1700–5300 m ³ /h	4100–12800 m ³ /h
Acoustic pressure level	55–65 dB(A)	44–69 dB(A)
BMS	via DRV ELiS	via DRV ELiS

The sound pressure level measured in a room with an average sound absorption capacity, 1500 m³; directivity factor Q = 2

APPLICATION



- shopping centers
- restaurants
- train stations



- industrial halls
- logistics centers
- warehouses



FLOWAIR R&D LAB

FLOWAIR - expert and manufacturer of HVAC equipment is a member of the EUROVENT Europe's Industry Association for Indoor Climate. This organisation brings together the largest companies in the industry, which jointly create new guidelines and recommendations that are eventually presented to the European Commission. The Association is looking for solutions related to energy savings inside buildings and the use of air curtains is one of recommended solutions.

The use of air curtains allows for thermal protection of the room. Curtains create an air barrier in the door opening and reduce heat losses / heat gains resulting from the inflow of cold air from outside in the winter, as well as inflow of warm air into the air-conditioned rooms during the summer. Presently, the regulations regarding energy losses when the doors are opened are not very clear.

A special project group at EUROVENT is currently developing a methodology for testing and describing air curtains in terms of their effectiveness to get a reliable comparison of their parameters. FLOWAIR - the only Polish producer participating in the project group has created a test stand to measure the effectiveness of air curtains. Based on the tests carried out and subsequent results, new tools will be created to simplify making informed investment decisions. Simply put, to help the end clients choose a proper solution.



I ADVANTAGES OF LABORATORY TESTING FOR THE CLIENT

At FLOWAIR, we constantly undertake activities aimed at increasing the quality of our products and services. A laboratory test is yet another step on the way to continuous product improvement and greater customer satisfaction.



Confirmed parameters



Reliable comparison



Energy -saving



Lower risk of investment

NEW FUTURE PROOF STANDARD

We strive for the highest quality of our products. Thanks to laboratory measurements of the effectiveness of air curtains, our customers can be sure that our devices will properly protect the door openings.



I TEST OF AIR CURTAIN EFFICIENCY IN RELATION TO TEMPERATURE DIFFERENCES

The test was carried out in the FLOWAIR R&D lab, in order to measure the effectiveness of the air barrier created by the air curtain relative to the temperature difference.

■ TEST 1

Measurement of air temperature difference between the „cooling“ and „heating“ chambers upon opening the door - with curtain in Off mode. Chamber 1 simulates external conditions (air temperature is 2°C), and chamber 2 simulates conditions inside the building (air temperature is 20°C).

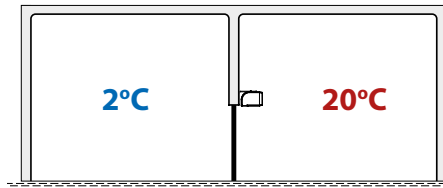

Simulation of external conditions - two closed chambers (cooling and heating).

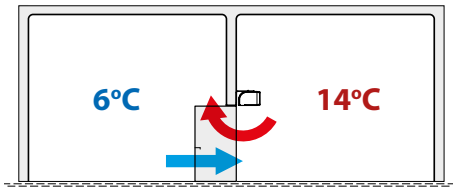

The door open for 60 seconds. Air temperature measurement with the curtain OFF.

■ TEST 2

The second measurement is the air curtain effectiveness test – the air temperature difference between the „cooling“ and „heating“ chambers upon opening the door with the air curtain ON.

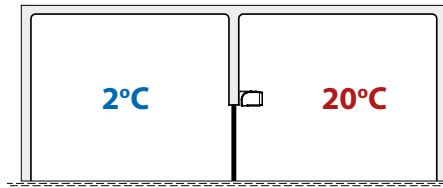

Simulation of external conditions - two closed chambers (cooling and heating).

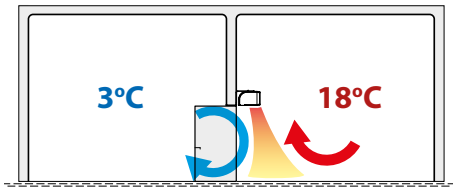

The door open for 60 seconds. Air temperature measurement with the curtain ON.

I TEST OF AIR CURTAIN EFFICIENCY IN RELATION TO AIRFLOW

Testing the effectiveness of the air curtain in relation to the airflow (wind simulation) allows you to assess the airflow of the curtain.

■ TEST 1

Stabilization of the vacuum pressure (-2.5 Pa) between the chambers and measurement of exhaust fan's efficiency with the door opened.

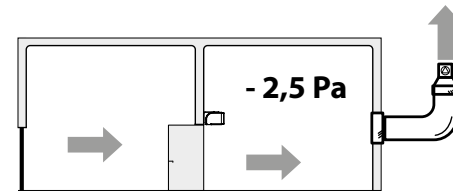

Stabilization of the vacuum pressure and efficiency of exhaust fan.

■ TEST 2

Efficiency test of exhaust fan with air curtain ON.

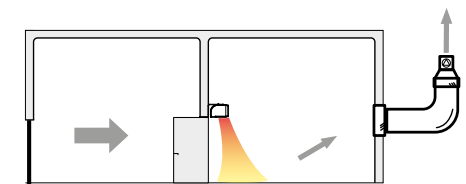

Measurement of the exhaust fan capacity with the air curtain ON.

I ISO STANDARD

The FLOWAIR door and gate curtain tests are carried out based on ISO standards, defining the aerodynamic properties of the air curtains (ISO 27327-1) and laboratory methods for testing the sound power level (ISO 27327-2). We take the requirements of the future ISO 27327-3 standard into account, specifying testing methods to determine the effectiveness of the air curtains.

NEW ELiS AX AIR CURTAIN

Advantages of AX

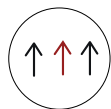

high efficiency



wide range of
heating power



quiet work
- EC fans



INSTALLATION

3 mounting possibilities

The ELiS AX curtain can be mounted both vertically and horizontally using dedicated consoles or brackets. Additionally, the curtain is equipped with integrated fasteners, so it can be suspended with threaded M8 rods, solution often used when mounting next to glass walls.

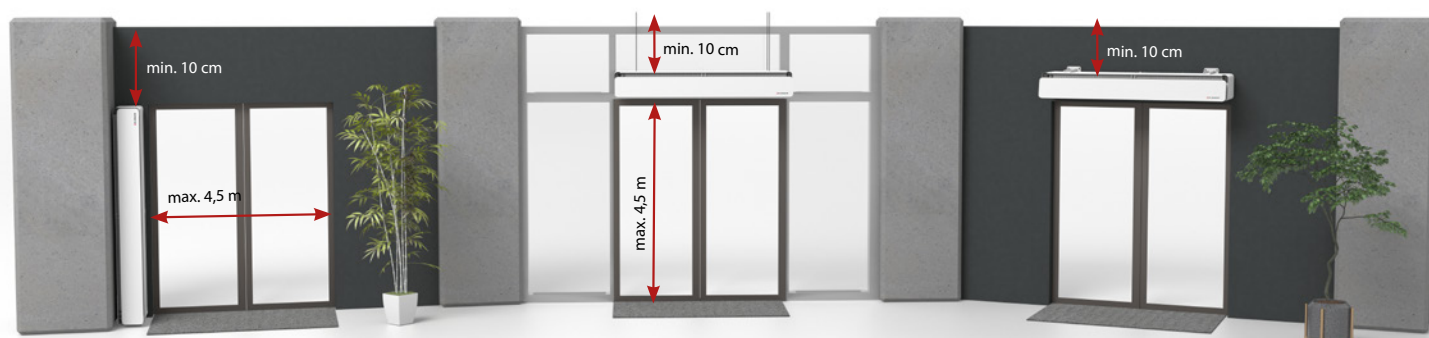

WHAT IS OPTIFLOW?

Comfort and economy

Optiflow technology ensures an **energy efficient airflow** through the aircurtain and guarantees high thermal comfort.

How does it work? The air enters the curtain **via 2 air intakes**: the lower and the upper intake. Then the air stream flows evenly throughout the entire area of the heat exchanger. Next the hot air stream passes through the fans and compression chamber and is directed towards two adjustable, dynamic outlet louvres which create 3 separate air streams, ensuring an excellent air barrier and additional thermal comfort in the room.

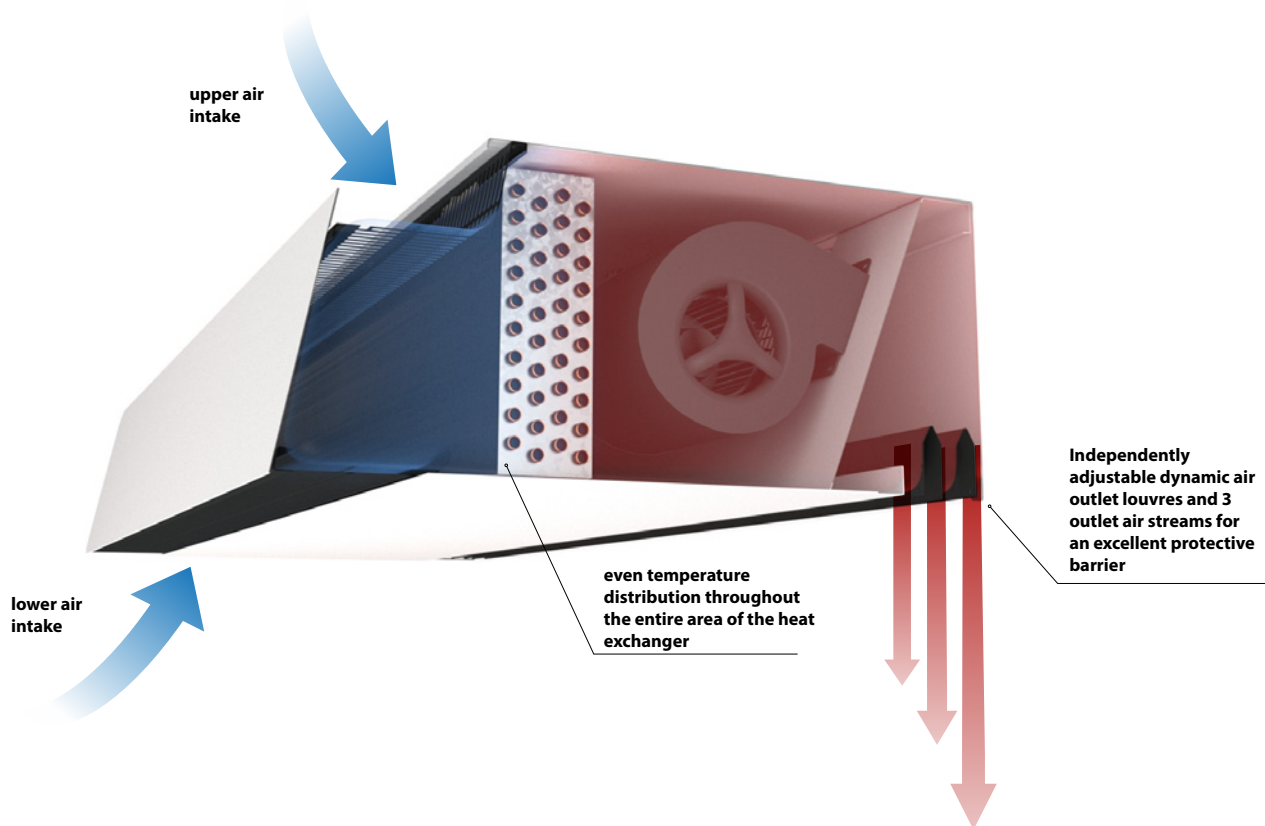

OPTiflow technology is:

- Thermal comfort in the room and energy savings thanks to even heat distribution throughout the entire area of the heat exchanger
- optimal room conditions as a result of independently controlled, dynamic air outlet louvres.
- an excellent barrier against external factors: warm and cool air, dust, smog, insects



AIR CURTAIN ELiS AX



ELiS AX 36

	Range ⁽¹⁾ [m] 3,6 m		Heating capacity ⁽²⁾ [kW] 7,9 – 38,0		Airflow [m ³ /h] 800 – 5300
--	--	---	---	---	--

ELiS AX 45

	Range ⁽¹⁾ [m] 4,5 m		Heating capacity ⁽²⁾ [kW] 10,0 – 41,4		Airflow [m ³ /h] 1000 – 6100
--	--	---	--	---	---

	Color White with black elements		Casing Steel
--	---	---	------------------------



DOWOLNY RAL
NA ZAPYTANIE

⁽¹⁾ according to ISO 27327-1

⁽²⁾ Power and temperature range for parameters: min. efficiency, temperature of the heating medium 40/30°C, temperature of the air at the inlet to devices 18°C - max. efficiency, heating medium temperature 60/40°C, air temperature at the inlet to the device 18°C

APPLICATION

ELiS AX curtains can be used in various facilities such as commercial buildings (cafes, restaurants, museums, shopping malls), and industrial buildings (warehouses, logistic centers, manufacturing plants) The devices are designed for horizontal installation directly above the door openings and for vertical installation at the sides of the opening. They are equipped with an advanced, built-in automation.

AVAILABLE TYPES OF UNITS:

- **4 LENGTHS**
1 m, 1,5 m, 2 m i 2,5 m
- **VERSIONS**
W – water heat exchanger

DIMENSIONS

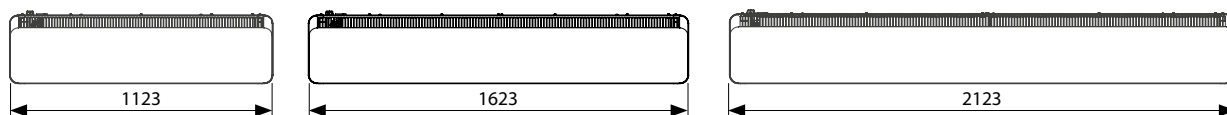

ELiS AX W-100

ELiS AX W-150

ELiS AX W-200

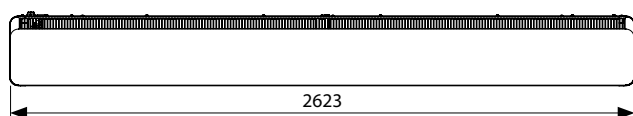

ELiS AX W-250

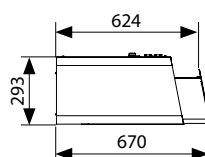

TECHNICAL DATA

Air curtains

ELiS AX

	ELiS AX36-W3R-100	ELiS AX36-W3R-150	ELiS AX36-W3R-200	ELiS AX36-W3R-250	ELiS AX36-W4R-100	ELiS AX36-W4R-150	ELiS AX36-W4R-200	ELiS AX36-W4R-250
Power supply [V/Hz]	230/50	230/50	230/50	230/50	230/50	230/50	230/50	230/50
Max. power consumption [kW]	0,27	0,40	0,67	0,81	0,27	0,40	0,67	0,81
Max. current consumption [A]	2,3	3,3	5,6	6,4	2,2	3,2	5,5	6,3
IP	21	21	21	21	21	21	21	21
Connection["]	3/4	3/4	3/4	3/4	3/4	3/4	3/4	3/4
Air flow ⁽¹⁾ [m ³ /h]	900 - 1800	1200-2700	2000-4300	2300-5300	800-1700	1100-2600	1900-4200	2200-5200
Acoustic pressure level ⁽²⁾ [dB(A)]	42-60	43-61	45-63	46-64	41-59	42-60	44-62	45-63
Acoustic power level ⁽³⁾ [dB(A)]	58-76	59-77	61-79	62-80	57-75	58-76	60-78	61-79
Heating capacity ⁽⁴⁾ [kW]	8,1-12,9	11,8-20,5	17,1-29,0	21,4-38,0	8,7-15,2	12,7-24,1	20,6-36,7	24,7-46,6
Max. water temperature [°C]	60	60	60	60	60	60	60	60
Max. operating pressure [MPa]	1,6	1,6	1,6	1,6	1,6	1,6	1,6	1,6
Max working temp. [°C]	30	30	30	30	30	30	30	30
Curtain's air temperature rise ⁽⁴⁾ (ΔT) [°C]	26-21	29-22	25-20	27-21	32-26	34-27	31-26	33-26
Unit weight [kg]	38,5	53,3	71,7	86,8	40,0	55,6	74,8	90,3
Range ⁽¹⁾ [m]	3,6	3,6	3,6	3,6	3,6	3,6	3,6	3,6

	ELiS AX45-W3R-100	ELiS AX45-W3R-150	ELiS AX45-W3R-200	ELiS AX45-W3R-250	ELiS AX45-W4R-100	ELiS AX45-W4R-150	ELiS AX45-W4R-200	ELiS AX45-W4R-250
Power supply [V/Hz]	230/50	230/50	230/50	230/50	230/50	230/50	230/50	230/50
Max. power consumption [kW]	0,49	0,65	0,99	1,15	0,49	0,65	0,99	1,15
Max. current consumption [A]	3,3	4,6	6,4	7,6	3,2	4,5	6,3	7,5
IP	21	21	21	21	21	21	21	21
Connection["]	3/4	3/4	3/4	3/4	3/4	3/4	3/4	3/4
Air flow ⁽¹⁾ [m ³ /h]	1100-2500	1500-3500	2200-5000	2400-6100	1000-2400	1400-3400	2100-4900	2300-6000
Acoustic pressure level ⁽²⁾ [dB(A)]	43-61	44-62	45-64	46-65	42-60	43-61	44-63	45-64
Acoustic power level ⁽³⁾ [dB(A)]	59-77	60-78	61-80	62-81	58-76	59-77	60-79	61-80
Heating capacity ⁽⁴⁾ [kW]	9,3-15,7	13,9-24,1	18,4-31,8	22,1-41,4	10,3-19,1	15,3-28,9	22,2-40,6	25,6-51,3
Max. water temperature [°C]	60	60	60	60	60	60	60	60
Max. operating pressure [MPa]	1,6	1,6	1,6	1,6	1,6	1,6	1,6	1,6
Max working temp. [°C]	30	30	30	30	30	30	30	30
Curtain's air temperature rise ⁽⁴⁾ (ΔT) [°C]	25-18	27-20	24-19	27-20	30-23	32-25	31-24	33-25
Unit weight [kg]	40,8	55,5	73,7	88,8	42,3	57,8	76,8	92,3
Range ⁽¹⁾ [m]	4,5	4,5	4,5	4,5	4,5	4,5	4,5	4,5

⁽¹⁾ According to ISO 27327-1

⁽²⁾ The sound pressure level measured in a room with an average sound absorption capacity, 1500 m³; direction factor Q = 2

⁽³⁾ Sound power level according to ISO 27327-1

⁽⁴⁾ Power and temperature range specified for parameters: min. efficiency, heating medium temperature 40/30°C, air temperature at the inlet to the device 18°C - max. efficiency, heating medium temperature 60/40°C, air temperature at the inlet to the device 18°C

CONNECTION DIAGRAMS

Built-in automation

T-box ZONE CONTROLLER

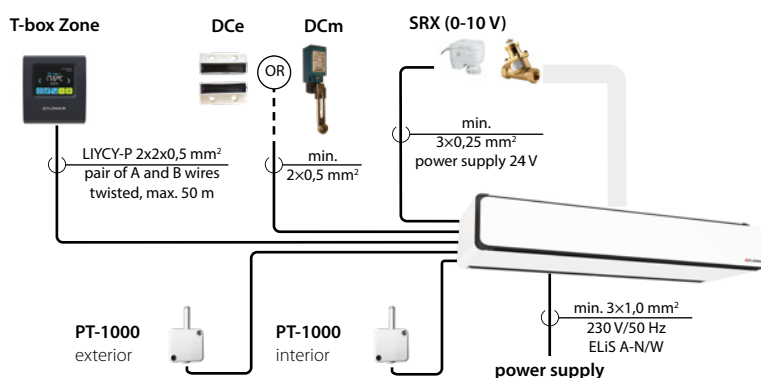

ELEMENTS:

- **T-Box Zone** – intelligent controller with touch screen and zoning function
- **DCe** – magnetic door sensor
- **DCm** – mechanical door sensor
- **SRX** – SRX balancing, modulating valve with an actuator

Two types of BMS

- Modbus
- Simple control signals (work-stop-failure)

HEATING CAPACITIES

Tw1/Tw2 = 60/40°C					Tw1/Tw2 = 50/40°C					Tw1/Tw2 = 45/35°C					Tw1/Tw2 = 40/30°C				
Tp1	PT	Qw	Δpw	Tp2	Tp1	PT	Qw	Δpw	Tp2	Tp1	PT	Qw	Δpw	Tp2	Tp1	PT	Qw	Δpw	Tp2
°C	kW	l/h	kPa	°C	°C	kW	l/h	kPa	°C	°C	kW	l/h	kPa	°C	°C	kW	l/h	kPa	°C
ELiS AX36-W3R-100																			
Airflow: 100%, V = 1800 m³/h																			
0,0	21,0	915	8,7	34,0	0,0	19,2	1675	26,9	31,5	0,0	17,0	1474	21,7	27,5	0,0	14,7	1273	16,8	24,0
10,0	16,5	721	5,6	37,0	10,0	14,9	1295	16,8	34,0	10,0	12,6	1095	12,6	30,5	10,0	10,3	893	8,8	26,5
20,0	11,9	520	3,1	39,5	20,0	10,4	909	8,8	37,0	20,0	8,1	706	5,6	33,0	20,0	5,7	497	3,0	29,5
ELiS AX36-W3R-150																			
Airflow: 100%, V = 2700 m³/h																			
0,0	32,8	1432	25,1	35,5	0,0	29,7	2583	75,0	32,0	0,0	26,2	2281	60,8	28,5	0,0	22,8	1980	47,8	24,5
10,0	26,1	1137	16,5	38,0	10,0	23,1	2008	47,3	35,0	10,0	19,7	1708	35,8	31,5	10,0	16,2	1406	25,6	27,5
20,0	19,1	835	9,4	40,5	20,0	16,4	1424	25,3	37,5	20,0	12,9	1121	16,6	34,0	20,0	9,4	812	9,4	30
ELiS AX36-W3R-200																			
Airflow: 100%, V = 4300 m³/h																			
0,0	49	2136	3,8	33,5	0,0	45,7	3983	12,4	31,0	0,0	40,1	3489	9,8	27,5	0,0	34,5	2992	7,5	23,5
10,0	38	1659	2,4	36,0	10,0	35,1	3059	7,6	34,0	10,0	29,5	2565	5,5	30,0	10,0	23,8	2061	3,7	26,0
20,0	26,7	1163	1,2	38,0	20,0	24,3	2116	3,8	36,5	20,0	18,5	1611	2,3	32,5	20,0	12,3	1070	1,1	28,5
ELiS AX36-W3R-250																			
Airflow: 100%, V = 5300 m³/h																			
0,0	62,6	2732	6,8	34,5	0,0	57,7	5026	21,5	32,0	0,0	50,8	4417	17,2	28,0	0,0	43,9	3806	13,2	24,0
10,0	49,1	2142	4,3	37,0	10,0	44,5	3877	13,3	34,5	10,0	37,6	3270	9,8	31,0	10,0	30,6	2655	6,8	27,0
20,0	35,1	1532	2,3	39,5	20,0	31,1	2709	6,8	37,0	20,0	24,1	2093	4,3	33,5	20,0	16,7	1450	2,2	29
ELiS AX36-W4R-100																			
Airflow: 100%, V = 1700 m³/h																			
0,0	24,1	1051	14,2	41,5	0,0	21,6	1884	41,9	37,0	0,0	19,2	1666	34,1	33,0	0,0	16,7	1448	26,9	28,5
10,0	19,2	836	9,4	43,0	10,0	16,8	1466	26,5	39,0	10,0	14,4	1249	20,2	34,5	10,0	11,9	1031	14,5	30,5
20,0	14,1	616	5,4	44,5	20,0	12,0	1044	14,3	40,5	20,0	9,5	824	9,5	36,5	20,0	6,9	597	5,4	32
ELiS AX36-W4R-150																			
Airflow: 100%, V = 2600 m³/h																			
0,0	37,8	1648	41,2	42,5	0,0	33,6	2926	119,1	38,0	0,0	29,8	2594	97,4	33,5	0,0	26,1	2262	77,5	29,5
10,0	30,2	1319	27,5	44,0	10,0	26,2	2285	76	39,5	10,0	22,5	1955	58,3	35,5	10,0	18,7	1623	42,4	31,0
20,0	22,6	984	16,2	45,5	20,0	18,8	1638	41,5	41,0	20,0	15,0	1304	28,0	37,0	20,0	11,1	963	16,5	32,5
ELiS AX36-W4R-200																			
Airflow: 100%, V = 4200 m³/h																			
0,0	58,4	2546	20	40,5	0,0	52,5	4569	60,1	36,5	0,0	46,5	4039	48,5	32,5	0,0	40,5	3510	38,0	28,0
10,0	46,4	2024	13,1	42,5	10,0	40,8	3554	37,7	38,5	10,0	34,8	3027	28,4	34,5	10,0	28,8	2497	20,2	30,0
20,0	34,2	1491	7,4	44,0	20,0	29,0	2528	20,1	40,0	20,0	22,9	1994	13,1	36,0	20,0	16,7	1446	7,4	31,5
ELiS AX36-W4R-250																			
Airflow: 100%, V = 5200 m³/h																			
0,0	73,6	3211	35	41,5	0,0	65,8	5728	103,7	37,0	0,0	58,3	5072	84,1	33,0	0,0	50,9	4416	66,2	28,5
10,0	58,7	2562	23,1	43,0	10,0	51,3	4465	65,4	39,0	10,0	43,9	3813	49,6	34,5	10,0	36,4	3157	35,7	30,5
20,0	43,6	1901	13,3	44,5	20,0	36,6	3190	35,2	40,5	20,0	29,1	2530	23,3	36,5	20,0	21,4	1855	13,4	32

V – air flow
 PT – heating capacity
 Tp1 – inlet air temperature
 Tp2 – outlet air temperature

Tw1 – inlet water temperature
 Tw2 – outlet water temperature
 Qw – water flow in the heat exchanger
 Δpw – water pressure drop in the heat exchanger

HEATING CAPACITIES

Tw1/Tw2 = 60/40°C					Tw1/Tw2 = 50/40°C					Tw1/Tw2 = 45/35°C					Tw1/Tw2 = 40/30°C				
Tp1	PT	Qw	Δpw	Tp2	Tp1	PT	Qw	Δpw	Tp2	Tp1	PT	Qw	Δpw	Tp2	Tp1	PT	Qw	Δpw	Tp2
°C	kW	l/h	kPa	°C	°C	kW	l/h	kPa	°C	°C	kW	l/h	kPa	°C	°C	kW	l/h	kPa	°C
ELiS AX45-W3R-100																			
Airflow: 100%, V = 2500 m³/h																			
0,0	25,7	1123	12,7	30,0	0,0	23,8	2068	39,7	28,0	0,0	20,9	1818	31,8	24,5	0,0	18,1	1569	24,7	21,0
10,0	20,2	883	8,2	33,5	10,0	18,4	1598	24,7	31,5	10,0	15,5	1348	18,4	28,0	10,0	12,6	1097	12,8	25,0
20,0	14,5	635	4,5	37,0	20,0	12,8	1117	12,8	35,0	20,0	10,0	865	8,2	31,5	20,0	7,0	608	4,4	28,0
ELiS AX45-W3R-150																			
Airflow: 100%, V = 3500 m³/h																			
0,0	38,7	1688	33,9	32,5	0,0	35,1	3060	102,2	29,5	0,0	31,1	2701	82,8	26,0	0,0	27,0	2342	65,0	22,5
10,0	30,7	1339	22,2	35,5	10,0	27,3	2377	64,4	33,0	10,0	23,2	2019	48,6	29,5	10,0	19,1	1659	34,6	26,0
20,0	22,5	980	12,6	39,0	20,0	19,3	1680	34,2	36,0	20,0	15,2	1320	22,4	32,5	20,0	11,0	953	12,6	29,0
ELiS AX45-W3R-200																			
Airflow: 100%, V = 5000 m³/h																			
0,0	53,8	2349	4,6	31,5	0,0	50,5	4394	14,9	29,5	0,0	44,3	3847	11,8	26,0	0,0	38,0	3297	9,0	22,0
10,0	41,8	1823	2,8	34,5	10,0	38,7	3371	9,1	32,5	10,0	32,5	2824	6,6	29,0	10,0	26,1	2267	4,5	25,5
20,0	29,3	1278	1,5	37,0	20,0	26,7	2328	4,5	35,5	20,0	20,4	1770	2,8	32,0	20,0	13,6	1180	1,3	28,0
ELiS AX45-W3R-250																			
Airflow: 100%, V = 6100 m³/h																			
0,0	68,5	2987	8,1	33,0	0,0	63,3	5512	25,6	30,5	0,0	55,7	4841	20,4	26,5	0,0	48,1	4169	15,6	23,0
10,0	53,8	2339	5,1	35,5	10,0	48,8	4249	15,7	33,5	10,0	41,2	3582	11,6	30,0	10,0	33,5	2905	8,0	26,0
20,0	38,3	1672	2,7	38,5	20,0	34,0	2965	8,1	36,5	20,0	26,3	2287	5,1	32,5	20,0	18,3	1584	2,6	29,0
ELiS AX45-W4R-100																			
Airflow: 100%, V = 2400 m³/h																			
0,0	30,6	1334	21,9	37,5	0,0	27,7	2408	65,7	33,5	0,0	24,5	2126	53,2	30,0	0,0	21,3	1844	41,8	26,0
10,0	24,2	1057	14,4	39,5	10,0	21,5	1870	41,4	36,0	10,0	18,3	1590	31,3	32,5	10,0	15,1	1307	22,3	28,5
20,0	17,8	775	8,2	41,5	20,0	15,2	1325	22,1	38,5	20,0	12,0	1041	14,5	34,5	20,0	8,7	751	8,1	30,5
ELiS AX45-W4R-150																			
Airflow: 100%, V = 3400 m³/h																			
0,0	45,6	1989	58	39,0	0,0	40,8	3551	169,5	35,0	0,0	36,2	3144	138,3	31,0	0,0	31,6	2738	109,6	27,0
10,0	36,4	1588	38,5	41,5	10,0	31,8	2769	107,7	37,5	10,0	27,2	2365	82,4	33,5	10,0	22,6	1959	59,7	29,5
20,0	27,0	1178	22,4	43,0	20,0	22,7	1977	58,4	39,5	20,0	18,1	1569	39,1	35,5	20,0	13,3	1154	22,8	31,5
ELiS AX45-W4R-200																			
Airflow: 100%, V = 4900 m³/h																			
0,0	64,9	2832	24,4	39,0	0,0	58,6	5099	73,7	35,0	0,0	51,8	4505	59,4	31,0	0,0	45,1	3911	46,4	27,0
10,0	51,5	2248	15,9	41,0	10,0	45,5	3963	46,1	37,0	10,0	38,8	3372	34,7	33,0	10,0	32,0	2777	24,6	29,0
20,0	37,9	1651	9,0	42,5	20,0	32,3	2812	24,4	39,5	20,0	25,5	2215	15,9	35,0	20,0	18,5	1603	8,9	31,0
ELiS AX45-W4R-250																			
Airflow: 100%, V = 6000 m³/h																			
0,0	81,3	3547	42,1	39,5	0,0	72,9	6348	125,4	35,5	0,0	64,6	5616	101,5	31,5	0,0	56,3	4886	79,8	27,5
10,0	64,8	2826	27,7	41,5	10,0	56,8	4944	79	37,5	10,0	48,5	4217	59,8	33,5	10,0	40,2	3488	42,8	29,5
20,0	47,9	2091	15,9	43,5	20,0	40,5	3524	42,3	39,5	20,0	32,1	2790	27,9	35,5	20,0	23,5	2041	16,0	31,5

V – air flow
 PT – heating capacity
 Tp1 – inlet air temperature
 Tp2 – outlet air temperature

Tw1 – inlet water temperature
 Tw2 – outlet water temperature
 Qw – water flow in the heat exchanger
 Δpw – water pressure drop in the heat exchanger



HEAT POWER CALCULATOR

Select a device for different parameters, scan QR code.

AIR CURTAIN Slim



Range⁽¹⁾ [m]
3,2

Heating capacity⁽²⁾ [kW]
1,2–29,3

Weight [kg]
14,7–26,9

Casing
Steel

Airflow [m³/h]
750–3000

2 colors as standard⁽³⁾
**White with black elements
and deep black**



**SPECIAL PAINTING
ON REQUEST**

⁽¹⁾ according to ISO 27327-1

⁽²⁾ Slim W power and temperature range specified for the parameters: fan speed III, heating medium temperature 40/30°C air temperature at the inlet to the device 20°C - fan speed III, heating medium temperature 110/90°C, air temperature at the inlet to the device 0°C; Slim E performance at power range: from 1N 230/50 to 3N 400/50

⁽³⁾ RAL 9003 and 9005. Any RAL color upon request

APPLICATION

The Slim curtain will work wherever doors are often opened, in shops, restaurants, service salons. Slim fits 99% of door openings. The curtain is designed for horizontal installation directly above the door opening and for vertical installation at the side parts of the opening.

AVAILABLE TYPES OF UNITS:

- **3 LENGTHS**
1 m, 1,5 m or 2 m
- **3 VERSIONS**
W – water heat exchanger (1- or 2-rows)
N – without heating elements („ambient“)
E – electric heaters

TECHNICAL DATA

Air curtains

Slim

	SLIM E-100	SLIM W-100	SLIM N-100	SLIM E-150	SLIM W-150	SLIM N-150	SLIM E-200	SLIM W-200	SLIM N-200
Power supply [V/Hz]	230 / 50 or 3x400 / 50	230 / 50	230 / 50	230 / 50 or 3x400 / 50	230 / 50	230 / 50	230 / 50 or 3x400 / 50	230 / 50	230 / 50
Max. power consumption [kW]	5,0	0,12	0,14	9,0	0,17	0,2	12,0	0,22	0,23
Max. current consumption [A]	8,5	0,5	0,6	13,0	0,7	0,8	17,3	0,9	1
IP	20	20	20	20	20	20	20	20	20
Connection[“]	–	½	–	–	½	–	–	½	–
Air flow ⁽¹⁾ [m ³ /h]	800–1300	750–1100	800–1400	1250–2200	1200–1950	1300–2300	1900–3000	1400–2850	1300–3000
Acoustic pressure level ⁽²⁾ [dB(A)] - 5 m	43–55,5	45–54,5	42,5–57	40–54	44–56	41–56	42–57	37–58	33,5–56
Acoustic power level ⁽³⁾ [dB(A)]	59–71,5	61–70,5	58,5–73	56–70	59–72	56–72	60–73	53–74	49,5–72
Heating capacity ⁽⁴⁾ [kW]	2–5	1,2–12,1	–	3–9	2,6–21,0	–	4–12	3,7–29,3	–
Max. water temperature [°C]	–	110	–	–	110	–	–	110	–
Max. operating pressure [MPa]	–	1,6	–	–	1,6	–	–	1,6	–
Curtain's air temperature rise ⁽⁴⁾ (ΔT) [°C]	4,0–24,0	3,0–32,5	–	6,0–32,0	4,0–32,0	–	6,0–26,0	4,0–30,5	–
Unit weight [kg]	15,1	16,2	14,7	19,6	21,5	19	24,6	26,9	23,8
Range ⁽¹⁾ [m]	3,2	3,2	3,2	3,2	3,2	3,2	3,2	3,2	3,2

⁽¹⁾ according to ISO 27327-1

⁽²⁾ the sound pressure level measured in a room with an average sound absorption capacity, 1500 m³; directivity factor Q = 2

⁽³⁾ sound power level according to ISO 27327-2

⁽⁴⁾ Slim W power and temperature range specified for the parameters: fan speed III, heating medium temperature 40/30°C air temperature at the inlet to the device 20°C - fan speed III, heating medium temperature 110/90°C air temperature at the inlet to the device 0°C; Slim E power range for operation at 1N 230/50 to operation at 3N 400/50

INSTALLATION

1 set of brackets - 3 mounting possibilities



BRACKETS FOR Slim
Invisible mounting system,
for both vertical and
horizontal mounting.



RODS
In standard Slim air
curtains have special
mounting holes for
installation with
threaded rods.

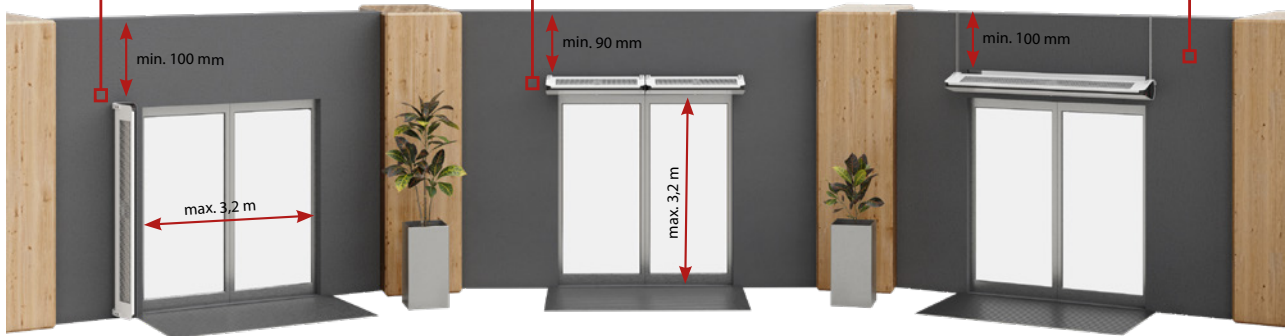

DIMENSIONS

The thinnest air curtain on the market

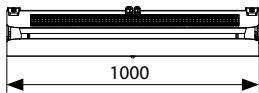

SLIM N|W|E-100

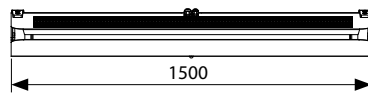

SLIM N|W|E-150

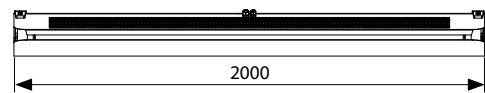

SLIM N|W|E-200

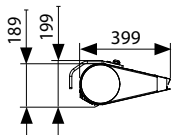

■ **CAD drawings** and documentation for all available versions of ELiS visit www.flowair.com



ADVANTAGES OF Slim AIR CURTAINS

4i Solution

I INTELLIGENT Intelligent savings

Motion sensor

The built-in motion sensor activates the curtain when motion is detected in the vicinity of the device. No additional door sensor or other automation elements are needed. Additionally, you can limit or extend the sensor's area of operation yourself.

Plug & Play

The Slim curtain has a built-in control for automatic operation in relation to the signal from the motion sensor. Thanks to this sensor, the device knows when to activate. Built-in switches on the side of the curtain allow you to adjust the air barrier to your needs.

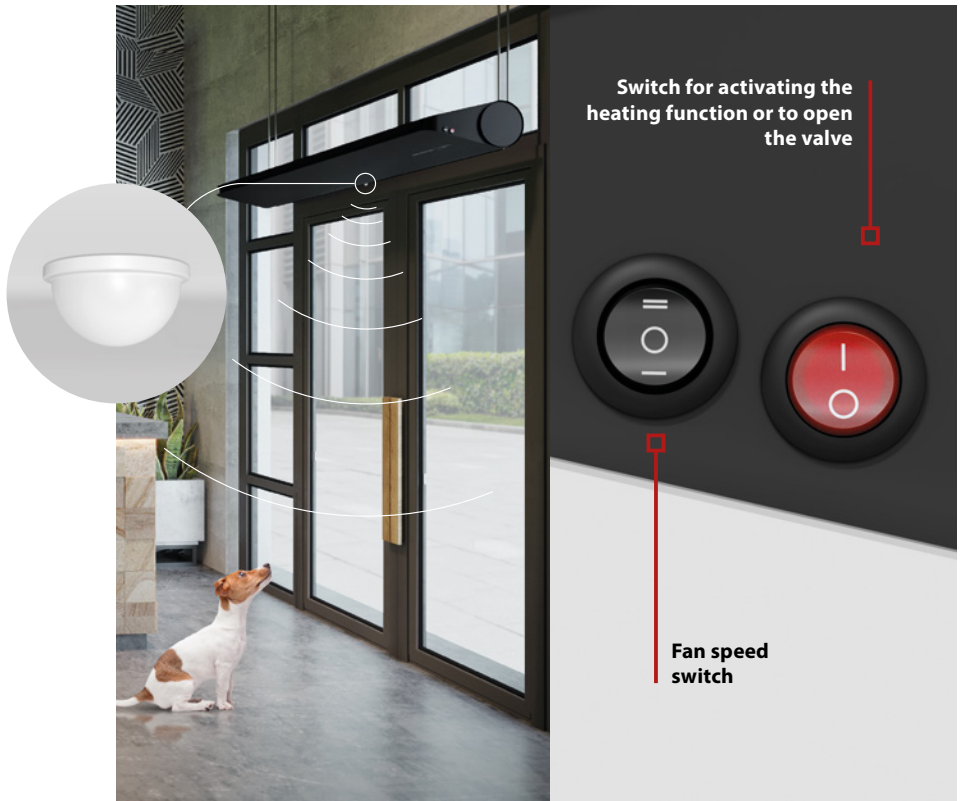

I IMPROVING AIR Air quality improvement

The design of the Slim air curtain allows for full protection against unwanted air inflow across the entire width of the door opening. The device is designed to work with an external filter module, which improves air quality and protects the device against the ingress of dirt and other pollutants.

Filter type: Coarse 30%
Thickness: 4mm



INVISIBLE Discreetness in action

The Slim curtain has been designed to be unobtrusive. It works quietly even at top speed. It is aesthetic and thin - almost invisible.



Deep black



White with black elements



IDEAL Perfect fit for your business

The Slim curtain will be a perfect fit for spaces where the doors are often opened and closed, for example in shops, restaurants and other commercial facilities.



99%

Perfect fit for 99% of door openings.

3,2 m

The recommended installation height; up to 3,2 m is enough to secure the door openings in most commercial facilities.

1 m = 100 cm

The thinnest curtain on the market. The device doesn't have any protruding side details - its length is always as stated. 100 cm Slim air curtain = 1 m.

AVAILABLE OPTIONS UPON REQUEST

TS + motion sensor



The solution will prove useful if you frequently change the curtain's settings and want to have the controller at your fingertips. Select the TS controller, which acts as a thermostat and switches on the heating elements.

TS + door sensor



This solution will prove useful when the motion sensor cannot operate freely due to some obstacles (e.g. a suspended element under the air curtain). In this case the devices' control depends on the signal from door sensor.

T-box



This solution will be useful when you want to connect the curtain to an intelligent building management system BMS. Choose this option if you need a weekly programmer or remote supervision over the operation of devices.

CONNECTION DIAGRAMS

PLUG&PLAY CONTROL

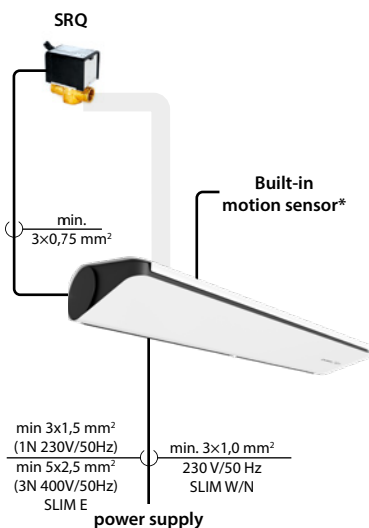

ELEMENTS:

- **PLUG & PLAY** – Built-in motion sensor
- **SRQ** – valve with actuator (for SLIM W)

TS CONTROLLER

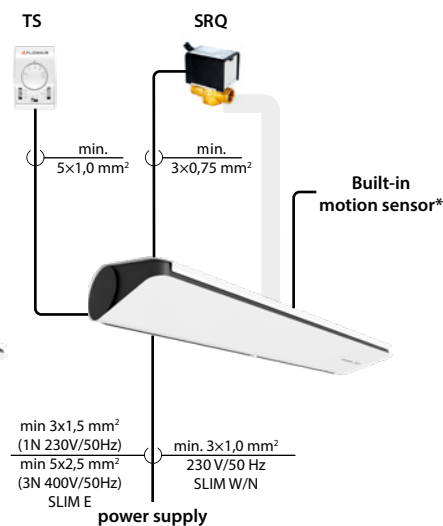

ELEMENTS:

- **TS** – 3-step fan speed controller with thermostat
- **SRQ** – valve with actuator (for SLIM W)

T-BOX CONTROLLER

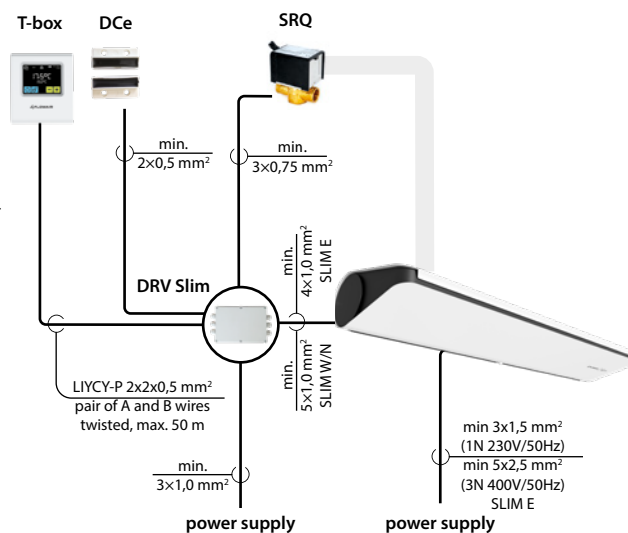

ELEMENTS:

- **T-box** – intelligent controller with touch screen
- **DRV Slim** – external control module
- **DCe** – magnetic door sensor
- **SRQ** – valve with actuator (for SLIM W)

* here is an option to use DCet door sensor instead of built-in motion sensor

HEATING CAPACITIES

Tw1/Tw2 = 90/70°C					Tw1/Tw2 = 80/60°C					Tw1/Tw2 = 70/50°C					Tw1/Tw2 = 60/40°C				
Tp1	PT	Qw	Δpw	Tp2	Tp1	PT	Qw	Δpw	Tp2	Tp1	PT	Qw	Δpw	Tp2	Tp1	PT	Qw	Δpw	Tp2
[°C]	[kW]	[l/h]	[kPa]	[°C]	[°C]	[kW]	[l/h]	[kPa]	[°C]	[°C]	[kW]	[l/h]	[kPa]	[°C]	[°C]	[kW]	[l/h]	[kPa]	[°C]
SLIM W-100																			
III step : V = 1100 m³/h																			
0,0	9.4	414	5.2	25.5	0,0	8.1	354	4.0	22.0	0,0	6.7	293	3.0	18.0	0,0	5.3	231	2.0	14.5
10,0	8.2	362	4.1	32.0	10,0	6.8	301	3.0	28.5	10,0	5.5	239	2.1	24.5	10,0	4.1	177	1.3	21.0
20,0	7.0	309	3.1	38.5	20,0	5.6	247	2.1	35.0	20,0	4.2	185	1.3	31.5	20,0	2.8	120	0.6	27.5
SLIM W-150																			
III step : V = 1950 m³/h																			
0,0	16.5	726	19.2	25.0	0,0	14.2	624	15.0	21.5	0,0	11.9	522	11.3	18.0	0,0	9.6	420	7.9	15.0
10,0	14.4	637	15.2	32.0	10,0	12.2	534	11.4	28.5	10,0	9.9	431	8.0	25.0	10,0	7.5	328	5.1	21.5
20,0	12.4	547	11.5	38.5	20,0	10.1	443	8.1	35.0	20,0	7.7	339	5.2	31.5	20,0	5.4	234	2.8	28.0
SLIM W-200																			
III step : V = 2850 m³/h																			
0,0	23.0	1016	42.2	24.0	0,0	19.9	874	33.1	21.0	0,0	16.8	734	24.9	17.5	0,0	13.6	594	17.6	14.5
10,0	20.2	892	33.3	31.0	10,0	17.1	750	25.0	27.5	10,0	13.9	608	17.7	24.5	10,0	10.7	467	11.5	21.0
20,0	17.4	768	25.3	38.0	20,0	14.2	624	17.9	34.5	20,0	11.0	480	11.6	31.5	20,0	7.7	336	6.4	28.0

V – air flow
 PT – heating capacity
 Tp1 – inlet air temperature
 Tp2 – outlet air temperature

Tw1 – inlet water temperature
 Tw2 – outlet water temperature
 Qw – water flow in the heat exchanger
 Δpw – water pressure drop in the heat exchanger



HEAT POWER CALCULATOR

Select a device for different parameters, scan QR code.

AIR CURTAINS ELiS T

Range⁽¹⁾ [m]
4

Heating capacity⁽²⁾ [kW]
0,8–58,9

Weight [kg]
20,7–37,5

Casing
**Steel, EPP,
plastic,
aluminium**

Air flow [m³/h]
1700–5300

Colour⁽³⁾
Grey



⁽¹⁾ According to ISO 27327-1

⁽²⁾ T-W power and temperature range specified for the parameters: fan speed III, heating medium temperature 40/30°C air temperature at the inlet to the device 20°C - fan speed III, heating medium temperature 90/70°C air temperature at the inlet to the device 0°C;

⁽³⁾ RAL 9007

APPLICATION

Modern shape and small size makes it suitable to install the units both in representative and industrial buildings. ELiS T air curtains are designed for both horizontal mounting – directly above the door openings – and vertical mounting on the side parts of the door opening.

AVAILABLE TYPES OF UNITS:

3 LENGTHS

1 m, 1,5 m or 2 m

3 VERSIONS

W – water heat exchanger (1- or 2-rows)

N – without heating elements („ambient“)

E – electric heaters

TECHNICAL DATA

Air curtains

ELiS T

	ELiS T-W- 100	ELiS T-W- 100 2R	ELiS T-N- 100	ELiS T-E- 100	ELiS T-W- 150	ELiS T-W- 150 2R	ELiS T-N- 150	ELiS T-E- 150	ELiS T-W- 200	ELiS T-W- 200 2R	ELiS T-N- 200	ELiS T-E- 200
Power supply [V/Hz]	230 / 50	230 / 50	230 / 50	3 x 400 / 50	230 / 50	230 / 50	230 / 50	3 x 400 / 50	230 / 50	230 / 50	230 / 50	3 x 400 / 50
Max. power consumption [kW]	0,38	0,38	0,39	7,5	0,4	0,4	0,42	11,5	0,44	0,44	0,46	15,5
Max. current consumption [A]	1,7	1,7	1,8	11	1,8	1,8	1,9	16,6	2,0	2,0	2,1	22,4
IP	21	21	21	21	21	21	21	21	21	21	21	21
Connection[“]	½“	½“	–	–	½“	½“	–	–	½“	½“	–	–
Air flow ⁽¹⁾ [m ³ /h]	1900– 2300	1700– 2100	2100– 2900	1900– 2300	3100– 3900	2900– 3700	3200– 4000	3100– 3900	3200– 5100	2800– 4900	3300– 5300	3200– 5100
Acoustic pressure level ⁽²⁾ [dB(A)] - 5 m	58–60	57–59	61–63	58–60	58–61	55–60	58–64	58–61	58–62	56–61	58–65	58–62
Acoustic power level ⁽³⁾ [dB(A)]	73–75	72–74	76–78	73–75	73–76	70–75	73–79	73–76	73–77	71–76	73–80	73–77
Heating capacity ⁽⁴⁾ [kW]	0,8–12,9	3,2–24,7	–	7,1–7,5	2,6–23,2	6,8–43,9	–	11,0–11,5	4,3–31,4	9,5–58,9	–	14,9–15,5
Max. water temperature [°C]	95	95	–	–	95	95	–	–	95	95	–	–
Max. operating pressure [MPa]	1,6	1,6	–	–	1,6	1,6	–	–	1,6	1,6	–	–
Curtain's air temperature rise ⁽⁴⁾ (ΔT) [°C]	1–17	5–35	–	11–12	2–18	6–35	–	12–13	3–19	6–36	–	13–14
Unit weight [kg]	22,1	23,5	20,7	24,0	29,5	32,0	27,0	31,5	34,3	37,5	31,5	37,0
Range ⁽¹⁾ [m]	4	4	4	4	4	4	4	4	4	4	4	4

⁽¹⁾ according to ISO 27327-1

⁽²⁾ the sound pressure level measured in a room with an average sound absorption capacity, 1500 m³; direction factor Q = 2

⁽³⁾ sound power level according to ISO 27327-2

⁽⁴⁾ T-W power and temperature range specified for the parameters: fan speed III, heating medium temperature 40/30°C air temperature at the inlet to the device 20°C - fan speed III, heating medium temperature 90/70°C air temperature at the inlet to the device 0°C; T-E power range for operation at fan speed I - fan speed III

INSTALLATION



BRACKET MPK
Possibility of vertical installation of ELiS T air curtains using brackets.



RODS
ELiS T air curtains can be mounted using threaded rods.

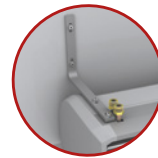

or

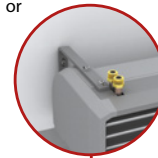

CONSOLE
Optional installation console enables easy and quick installation of the air curtain on the wall in two ways.



DIMENSIONS

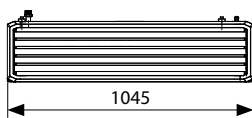

T-N|W|E-100

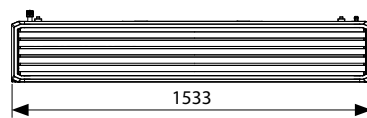

T-N|W|E-150

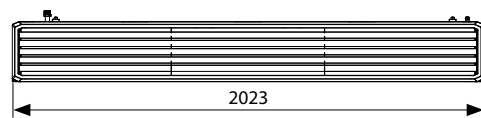

T-N|W|E-200

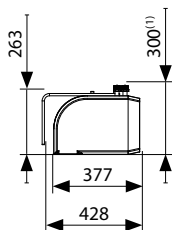

■ **CAD drawings** and documentation for all available versions of ELiS visit www.flowair.com



⁽¹⁾ the dimension refers to a curtain with an ELiS T-W exchanger

CONNECTION DIAGRAMS

TS CONTROLLER

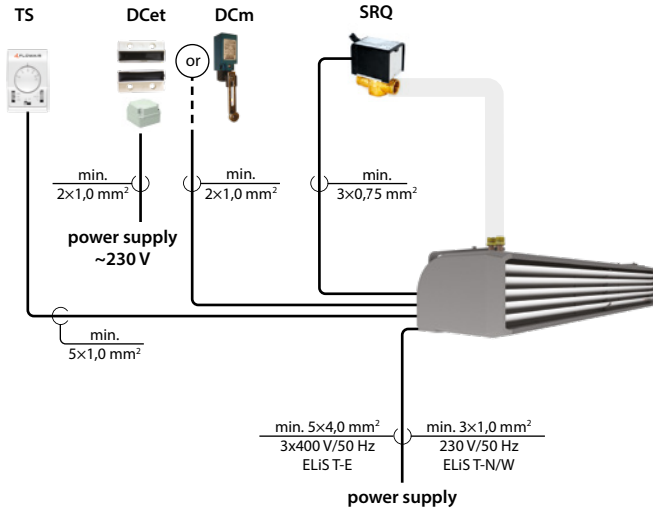

ELEMENTS:

- **TS** – 3-step fan speed controller with thermostat
- **DCeT** – magnetic door sensor with relay box
- **DCm** – mechanical door sensor
- **SRQ** – valve with actuator

T-box CONTROLLER

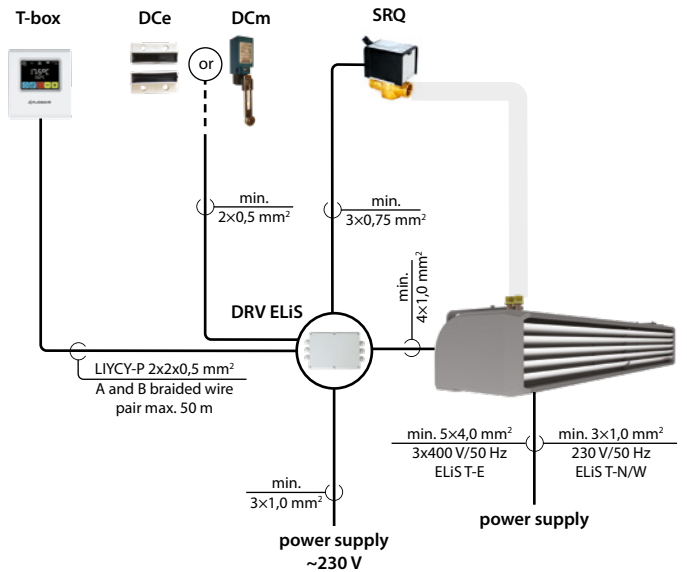

ELEMENTS:

- **T-box** – intelligent controller with touch screen
- **DRV ELiS** – external control module
- **DCe** – magnetic door sensor
- **DCm** – mechanical door sensor
- **SRQ** – valve with actuator



ELiS T – UNIVERSAL INSTALLATION

HEATING CAPACITIES

Tw1/Tw2 = 90/70°C					Tw1/Tw2 = 80/60°C					Tw1/Tw2 = 70/50°C					Tw1/Tw2 = 60/40°C				
Tp1	PT	Qw	Δpw	Tp2	Tp1	PT	Qw	Δpw	Tp2	Tp1	PT	Qw	Δpw	Tp2	Tp1	PT	Qw	Δpw	Tp2
[°C]	[kW]	[l/h]	[kPa]	[°C]	[°C]	[kW]	[l/h]	[kPa]	[°C]	[°C]	[kW]	[l/h]	[kPa]	[°C]	[°C]	[kW]	[l/h]	[kPa]	[°C]
ELiST-W-100																			
III step : V = 2300 m³/h																			
0,0	12,9	571	2	17	0,0	10,8	476	1,5	14,0	0,0	8,7	379	1	11	0,0	6,3	276	0,6	8
10,0	11,1	492	1,5	24,5	10,0	9	395	1,1	21,5	10,0	6,8	296	0,7	18,5	10,0	4,2	183	0,3	15
20,0	9,3	411	1,1	32	20,0	7,1	314	0,7	29,	20,0	4,8	210	0,4	26	20,0	1,7	73	0,1	22
ELiST-W-150																			
III step : V = 3900 m³/h																			
0,0	23,2	1026	7,2	17,5	0,0	19,8	870	5,5	15,0	0,0	16,3	714	4	12	0,0	12,8	556	2,6	9
10,0	20,2	892	5,6	25	10,0	16,7	735	4	22,5	10,0	13,2	578	2,7	20	10,0	9,6	417	1,6	16,5
20,0	17,2	757	4,1	32,5	20,0	13,6	599	2,8	30,0	20,0	10	439	1,6	27,5	20,0	6,2	272	0,07	24
ELiST-W-200																			
III step : V = 5100 m³/h																			
0,0	31,4	1387	14,5	18	0,0	26,9	1183	11,1	15,0	0,0	22,4	980	8,1	12,5	0,0	17,8	776	5,5	10
10,0	27,4	1211	11,3	26	10,0	22,9	1005	8,2	23,0	10,0	18,3	801	5,6	20,5	10,0	13,6	595	3,4	18
20,0	23,4	1033	8,4	33	20,0	18,8	826	5,8	30,5	20,0	14,4	619	3,5	27,5	20,0	9,4	408	1,7	25
ELiST-W-100 2R																			
III step : V = 2100 m³/h																			
0,0	22,6	998	1,57	32	0,0	18,9	832	1,16	27,0	0,0	15,1	662	0,79	21	0,0	11	479	0,46	16
10,0	19,5	858	1,19	37	10,0	15,7	691	0,83	32,0	10,0	11,8	517	0,51	27	10,0	6,96	304	0,2	19
20,0	16,3	718	0,86	43	20,0	12,5	547	0,54	37,0	20,0	8,3	362	0,27	31	20,0	3,17	138	0,5	24
ELiST-W-150 2R																			
III step : V = 3700 m³/h																			
0,0	41,5	1833	5,9	33	0,0	35,4	1555	4,48	28	0,0	29,2	1276	3,22	23	0,0	22,8	994	2,1	18
10,0	36,1	1592	4,6	39	10,0	29,9	1313	3,29	34	10,0	23,6	1032	2,2	29	10,0	17,1	746	1,27	24
20,0	30,6	1351	3,4	44	20,0	24,3	1069	2,27	39	20,0	17,9	785	1,34	34	20,0	11,1	483	0,58	29
ELiST-W-200 2R																			
III step : V = 4900 m³/h																			
0,0	56,5	2494	11,95	34	0,0	48,4	2127	9,17	29	0,0	40,3	1762	6,7	24	0,0	32	1396	4,54	19
10,0	49,3	2174	9,28	40	10,0	41,1	1806	6,8	35	10,0	32,9	1439	4,64	30	10,0	24,5	1069	2,81	25
20,0	42	1854	6,93	45	20,0	33,7	1483	4,75	40	20,0	25,4	1111	2,91	35	20,0	16,8	732	1,43	30

V – air flow
 PT – heating capacity
 Tp1 – inlet air temperature
 Tp2 – outlet air temperature

Tw1 – inlet water temperature
 Tw2 – outlet water temperature
 Qw – water flow in the heat exchanger
 Δpw – water pressure drop in the heat exchanger



HEAT POWER CALCULATOR

Select a device for different parameters, scan QR code.

AIR CURTAINS

ELiS B



Range⁽¹⁾ [m]
5

Heating capacity⁽²⁾ [kW]
0,9–59,0

Weight [kg]
31,7–53,2

Casing
**Steel,
plastic,
aluminium**

Air flow [m³/h]
2000–6600

Colour⁽³⁾
White



**SPECIAL PAINTING
ON REQUEST**

⁽¹⁾ According to ISO 27327-1

⁽²⁾ B-W power and temperature range specified for the parameters: fan speed III, heating medium temperature 40/30°C air temperature at the inlet to the device 20°C - fan speed III, heating medium temperature 90/70°C air temperature at the inlet to the device 0°C;

B-E power range for operation fan speed I - fan speed III

⁽³⁾ RAL 9016

APPLICATION

ELiS B air curtains are dedicated for shops, restaurants, exhibition rooms. Units are designed for installation in the ceilings. Advantage is the possibility to install in the existing ceiling without cutting additional holes.

AVAILABLE TYPES OF UNITS:

- **3 LENGTHS**
1 m, 1,5 m or 2 m
- **3 VERSIONS**
W – water heat exchanger (1- or 2-rows)
N – without heating elements („ambient“)
E – electric heaters

TECHNICAL DATA

Air curtains

ELiS B

	ELiS B-W-100	ELiS B-W-100 2R	ELiS B-N-100	ELiS B-E-100	ELiS B-W-150	ELiS B-W-150 2R	ELiS B-N-150	ELiS B-E-150	ELiS B-W-200	ELiS B-W-200 2R	ELiS B-N-200	ELiS B-E-200
Power supply [V/Hz]	230 / 50	230 / 50	230 / 50	3 x 400 / 50	230 / 50	230 / 50	230 / 50	3 x 400 / 50	230 / 50	230 / 50	230 / 50	3 x 400 / 50
Max. power consumption [kW]	0,34	0,34	0,42	7,5	0,36	0,36	0,42	11,5	0,38	0,38	0,49	15,5
Max. current consumption [A]	1,5	1,5	1,9	11	1,6	1,6	2	16,6	1,7	1,7	2,2	22,4
IP	21	21	21	21	21	21	21	21	21	21	21	21
Connection[“]	½“	½“	–	–	½“	½“	–	–	½“	½“	–	–
Air flow ⁽¹⁾ [m ³ /h]	2200–2600	2000–2400	2300–3500	2200–2600	3200–4000	3000–3800	3200–4800	3200–4000	4000–5200	3800–4900	3600–6600	4000–5200
Acoustic pressure level ⁽²⁾ [dB(A)] - 5 m	55–58	55–57	61–65	55–58	57–62	56–60	58–65	57–62	58–63	56–61	59–66	58–63
Acoustic power level ⁽³⁾ [dB(A)]	70–73	70–72	76–80	70–73	72–77	71–75	73–80	72–77	73–78	71–76	74–81	73–78
Heating capacity ⁽⁴⁾ [kW]	0,9–13,8	3,5–26,7	–	7,1–7,5	2,6–23,6	6,9–44,6	–	11,0–11,5	4,4–31,8	9,5–59,0	–	14,9–15,5
Max. water temperature [°C]	95	95	–	–	95	95	–	–	95	95	–	–
Max. operating pressure [MPa]	1,6	1,6	–	–	1,6	1,6	–	–	1,6	1,6	–	–
Curtain's air temperature rise ⁽⁴⁾ (ΔT) [°C]	1–16	4–33	–	11–12	2–18	5–35	–	12–13	3–18	6–36	–	13–14
Unit weight [kg]	32,3	33,7	31,7	34,5	41,2	43,7	38,9	42,4	50	53,2	47,2	53,2
Range ⁽¹⁾ [m]	5	5	5	5	5	5	5	5	5	5	5	5

⁽¹⁾ according to ISO 27327-1

⁽²⁾ the sound pressure level measured in a room with an average sound absorption capacity, 1500 m³; direction factor Q = 2

⁽³⁾ sound power level according to ISO 27327-2

⁽⁴⁾ B-W power and temperature range specified for the parameters: fan speed III, heating medium temperature 40/30°C air temperature at the inlet to the device 20°C - fan speed III, heating medium temperature 90/70°C air temperature at the inlet to the device 0°C; B-E power range for operation at fan speed I - fan speed III

INSTALLATION

BRACKETS

Brackets with mounting holes for installation using threaded rods are included.

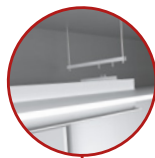

Installation of the unit doesn't require additional holes in the ceiling.

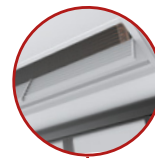

Access from the front makes installation, connection and cleaning of the air curtain much easier.



DIMENSIONS

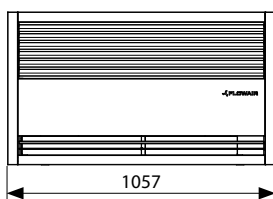

B-N|W|E-100

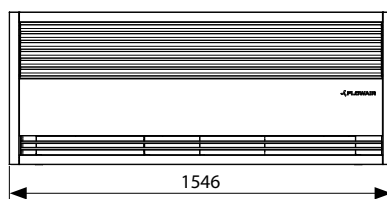

B-N|W|E-150

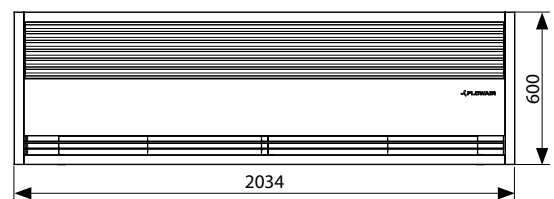

B-N|W|E-200

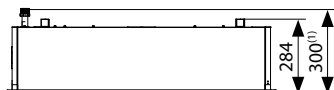

■ **CAD drawings** and documentation for all available versions of ELiS visit www.flowair.com



¹⁾ the dimension refers to a curtain with an ELiS B-W exchanger

CONNECTION DIAGRAMS

TS CONTROLLER

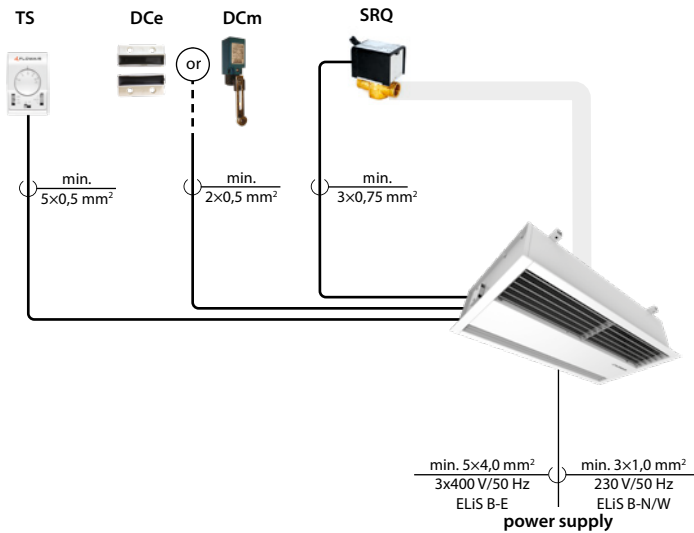

ELEMENTS:

- **TS** – 3-step fan speed controller with thermostat
- **DCe** – magnetic door sensor
- **DCm** – mechanical door sensor
- **SRQ** – valve with actuator

T-box CONTROLLER

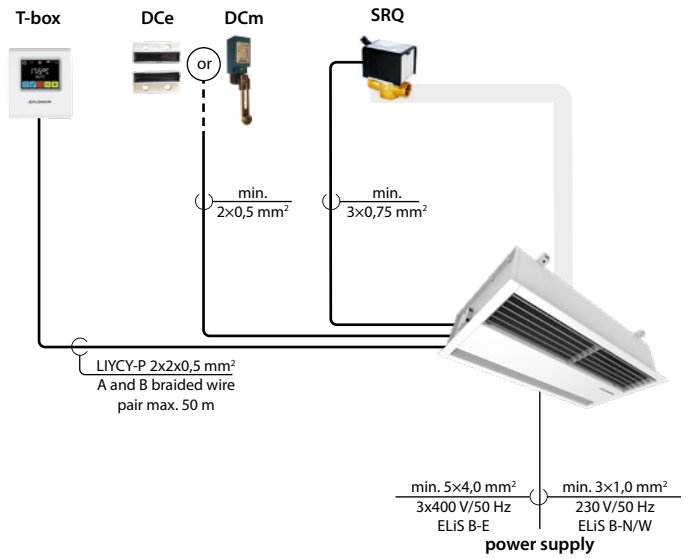

ELEMENTS:

- **T-box** – intelligent controller with touch screen
- **DCe** – magnetic door sensor
- **DCm** – mechanical door sensor
- **SRQ** – valve with actuator

ELiS B – RECESSED AIR CURTAINS



HEATING CAPACITIES

Tw1/Tw2 = 90/70°C					Tw1/Tw2 = 80/60°C					Tw1/Tw2 = 70/50°C					Tw1/Tw2 = 60/40°C				
Tp1	PT	Qw	Δpw	Tp2	Tp1	PT	Qw	Δpw	Tp2	Tp1	PT	Qw	Δpw	Tp2	Tp1	PT	Qw	Δpw	Tp2
[°C]	[kW]	[l/h]	[kPa]	[°C]	[°C]	[kW]	[l/h]	[kPa]	[°C]	[°C]	[kW]	[l/h]	[kPa]	[°C]	[°C]	[kW]	[l/h]	[kPa]	[°C]
ELiS B-W-100																			
III step : V = 2600 m³/h																			
0,0	13,8	609	2,3	15,5	0,0	11,5	507	1,7	13,0	0,0	9,2	404	1,2	10,5	0,0	6,8	295	0,7	7,5
10,0	11,9	524	1,7	24,5	10,0	9	395	1,1	21,5	10,0	7,2	316	0,7	18,0	10,0	4,6	198	0,3	15,0
20,0	9,9	438	1,2	31,0	20,0	7,6	334	0,8	28,5	20,0	5,1	225	0,4	25,0	20,0	1,7	74	0,1	22,0
ELiS B-W-150																			
III step : V = 4000 m³/h																			
0,0	23,5	1039	7,4	17,5	0,0	20,0	881	5,6	15,0	0,0	16,5	723	4,0	12,5	0,0	13,0	563	2,7	9,5
10,0	20,5	904	5,7	25,0	10,0	17,0	745	4,1	22,5	10,0	13,4	585	2,8	20,0	10,0	9,7	423	1,6	17,0
20,0	17,4	767	4,2	32,5	20,0	13,8	607	2,8	30,0	20,0	10,2	445	1,7	27,5	20,0	6,3	276	0,7	24,5
ELiS B-W-200																			
III step : V = 5200 m³/h																			
0,0	31,8	1402	14,7	18,0	0,0	27,7	1195	11,3	15,5	0,0	22,5	990	8,3	13,0	0,0	18,0	784	5,6	10,5
10,0	27,7	1223	11,5	25,7	10,0	23,1	1016	8,4	22,5	10,0	18,5	809	5,7	20,5	10,0	13,8	601	3,5	18,0
20,0	23,6	1043	8,8	33,0	20,0	19,0	834	5,9	30,5	20,0	14,3	625	3,6	28,0	20,0	9,5	412	1,8	25,0
ELiS B-W-100 2R																			
III step : V = 2400 m³/h																			
0,0	24,5	1080	1,82	30	0,0	20,5	900	1,34	27,0	0,0	11,8	716	0,91	20	0,0	12	521	0,53	15
10,0	21	928	1,38	36	10,0	17	747	0,95	31	10,0	12,8	560	0,58	26	10,0	7,8	341	0,25	20
20,0	17,6	776	0,99	41	20,0	13,5	592	0,63	36	20,0	9	395	0,31	31	20,0	3,3	142	0,05	24
ELiS B-W-150 2R																			
III step : V = 3800 m³/h																			
0,0	42,2	1863	6,1	33	0,0	36	1580	4,6	28	0,0	29,6	1296	3,3	23	0,0	23,2	1010	2,2	18
10,0	39,4	1618	4,7	38,5	10,0	30,4	1334	3,4	33,5	10,0	24	1049	2,3	28,5	10,0	17,4	758	1,3	23,5
20,0	31,1	1373	3,5	44	20,0	24,7	1086	2,3	39	20,0	18,2	797	1,4	34	20,0	11,3	492	0,6	28,5
ELiS B-W-200 2R																			
III step : V = 4900 m³/h																			
0,0	57,2	2524	12,2	34	0,0	49	2153	9,37	29	0,0	40,8	1783	6,85	24	0,0	32,4	1413	4,64	19
10,0	49,9	2200	9,49	39	10,0	41,6	1828	6,95	34	10,0	33,3	1456	4,74	30	10,0	24,8	1082	2,87	25
20,0	42,5	1876	7,09	45	20,0	34,2	1501	4,85	40	20,0	25,7	1125	2,97	35	20,0	17	741	1,46	30

V – air flow
 PT – heating capacity
 Tp1 – inlet air temperature
 Tp2 – outlet air temperature

Tw1 – inlet water temperature
 Tw2 – outlet water temperature
 Qw – water flow in the heat exchanger
 Δpw – water pressure drop in the heat exchanger



HEAT POWER CALCULATOR

Select a device for different parameters, scan QR code.

AIR CURTAINS ELiS G

Range⁽¹⁾ [m]
8,0

Heating capacity⁽²⁾ [kW]
7,8–66,7

Weight [kg]
43,0–77,9

Casing
Galvanized steel

Air flow [m³/h]
2500–12800

Colour
Grey, silver



**SPECIAL PAINTING
ON REQUEST**

⁽¹⁾ According to ISO 27327-1

⁽²⁾ G-W power and temperature range specified for the parameters: fan speed III, heating medium temperature 40/30°C air temperature at the inlet to the device 20°C - fan speed III, heating medium temperature 90/70°C air temperature at the inlet to the device 0°C; G-E power range for operation fan speed I - fan speed III

AVAILABLE TYPES OF UNITS:

- **3 LENGTHS**
1,5m, 2m or 2,5m
- **3 VERSIONS**
W – water heat exchanger (1- or 2-rows)
N – without heating elements („ambient“)
E – electric heaters

APPLICATION

Warehouses, halls, logistics centers. ELiS G devices are intended for horizontal and vertical installation. They create an air barrier that reduces the various losses associated with the exchange of air between the room and the outside area.

TECHNICAL DATA

Air curtains

ELiS G

	G-E-150	G-N-150	G-W-150	G-W-150 2R	G-E-200	SLIM-N-200	G-W-200	G-W-200 2R	G-E-250	G-N-250	G-W-250
Power supply [V/Hz]	3x400 / 50	230 / 50	230 / 50	230 / 50	3x400 / 50	230 / 50	230 / 50	230 / 50	3x400 / 50	230 / 50	230 / 50
Max. power consumption [kW] ⁽¹⁾	13,5 + 0,68	0,67	0,67	0,67	20,5 + 1,05	1,05	1,05	1,05	24,5 + 1,4	1,4	1,4
Max. current consumption [A] ⁽¹⁾	19,5 + 3,0	3	3	3	29,5 + 4,5	4,5	4,5	4,5	36,0 + 6,0	6	6
IP	20	54	54	54	20	54	54	54	20	54	54
Connection["]	-	-	3/4	3/4	-	-	3/4	3/4	-	-	3/4
Air flow [m ³ /h] ⁽²⁾	2600-6300	2800-6550	2500-6200	2400-6100	3400-9400	3900-9700	3300-9100	3100-8800	4900-12400	4900-12800	4300-12000
Acoustic pressure level [dB(A)] - 5 m ⁽³⁾	44-65	44-65	45-66	46-67	45-66	45-66	46-68	47-69	46-68	46-68	47-69
Acoustic pressure level [dB(A)] - 3 m ⁽³⁾	45-66	45-66	46-67	47-68	46-67	46-67	47-69	48-70	47-69	47-69	48-70
Acoustic power level [dB(A)] ⁽⁴⁾	60-81	60-81	61-82	62-83	61-82	61-82	62-84	63-85	62-84	62-84	63-85
Heating capacity [kW] ⁽⁵⁾	13,5	-	7,8-27	16,8-60,1	20,5	-	8,7-30,0	19,2-68,5	24,5	-	15,0-49,6
Max. water temperature [°C]	-	-	120	120	-	-	120	120	-	-	120
Max. operating pressure [MPa]	-	-	1,6	1,6	-	-	1,6	1,6	-	-	1,6
Curtain's air temperature rise (ΔT) [°C] ⁽⁵⁾	7,0-16,0	-	4,0-13,0	8,0-29,0	7,0-18,0	-	3,0-11,0	8,0-26,0	7,5-16,5	-	4,0-12,0
Unit weight [kg]	47	43	47,4	51,8	62,2	58	62	66,4	77,9	71,5	78,3
Range [m] ⁽²⁾	7,5	8	7,5	7,5	7,5	8	7,5	7,5	7,5	8	7,5

⁽¹⁾ for G-E, the parameters of heating elements powered by 3N 400V and fans powered by 1N 230V are given, respectively

⁽²⁾ in accordance with ISO 27327-1

⁽³⁾ acoustic pressure level has been measured in a 1500m³ space with a medium sound absorption coefficient, directional factor: Q=2

⁽⁴⁾ acoustic power level according to ISO 27327-2

⁽⁵⁾ G-W range of heating powers and temperatures specified for the parameters: III fan speed, heating medium temperature 40/30 0 °C inlet temperature 20 °C - III fan speed, heating medium temperature 110/90 °C at the device inlet 0 °C; G E power range for operation at 1N 230/50 to operation at 3N 400/50

INSTALLATION

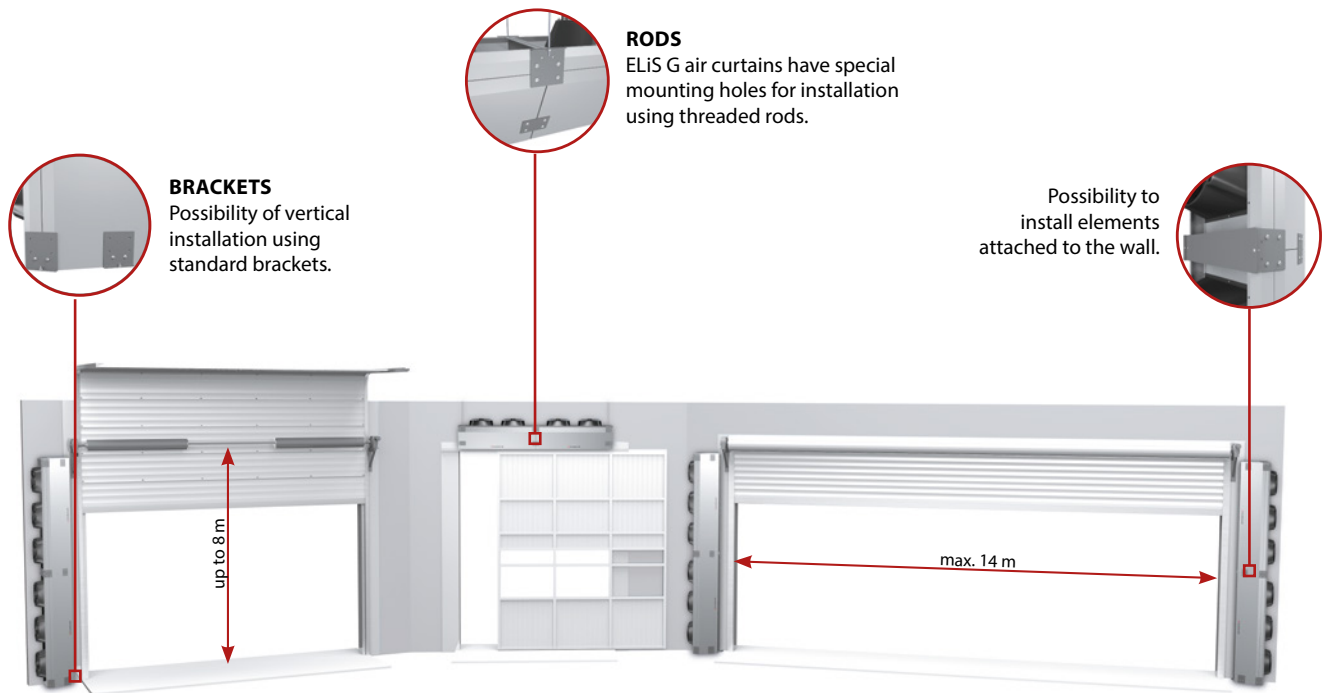

DIMENSIONS

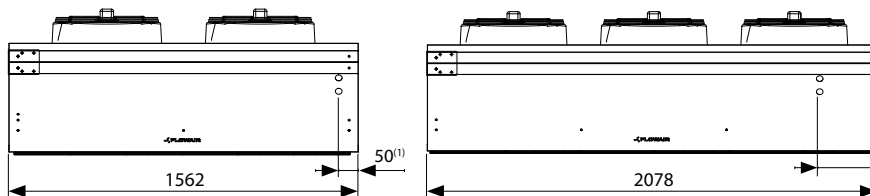

G-150

G-200

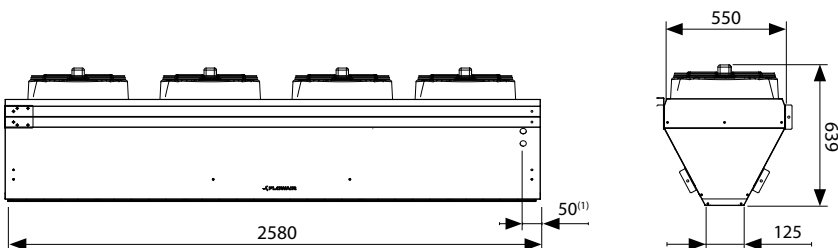

G-250

■ For CAD drawings, Revit files and documentation for all available versions of ELiS visit www.flowair.com



⁽¹⁾ the dimension refers to ELiS G-W curtain with water heat exchanger

CONNECTION DIAGRAMS

TS CONTROLLER

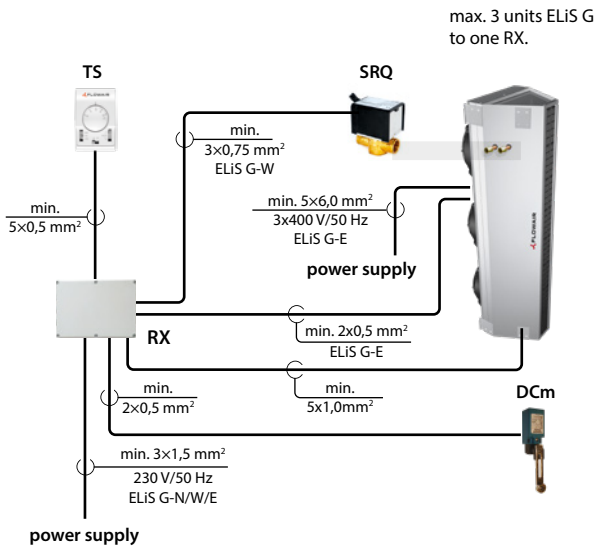

ELEMENTS:

- **TS** – 3-step fan speed controller with thermostat (can control up to 1 pc. of ELiS G without using RX)
- **RX** – signal splitter for 3 ELiS G curtains
- **DCm** – mechanical door sensor
- **SRQ** – valve with actuator

T-box CONTROLLER

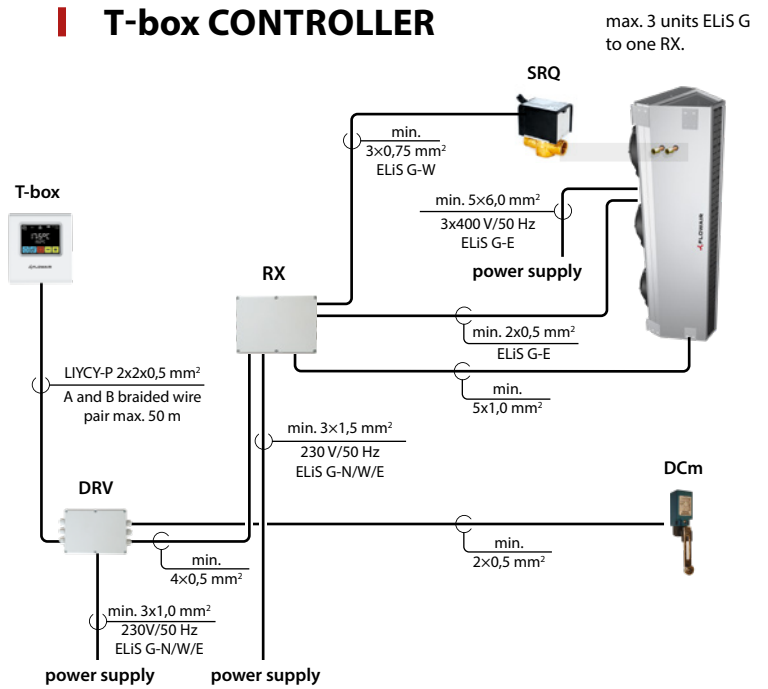

ELEMENTS:

- **T-box** – intelligent controller with touch screen
- **DRV ELiS** – external control module
- **RX** – signal splitter for 3 ELiS G curtains
- **DCm** – mechanical door sensor
- **SRQ** – valve with actuator



ELiS G – WHEN RANGE IS PRIORITY

HEATING CAPACITIES

Tw1/Tw2 = 90/70°C					Tw1/Tw2 = 80/60°C					Tw1/Tw2 = 70/50°C					Tw1/Tw2 = 60/40°C				
Tp1	PT	Qw	Δpw	Tp2	Tp1	PT	Qw	Δpw	Tp2	Tp1	PT	Qw	Δpw	Tp2	Tp1	PT	Qw	Δpw	Tp2
[°C]	[kW]	[l/h]	[kPa]	[°C]	[°C]	[kW]	[l/h]	[kPa]	[°C]	[°C]	[kW]	[l/h]	[kPa]	[°C]	[°C]	[kW]	[l/h]	[kPa]	[°C]

ELiS G-W-150

III step: V = 6200 m³/h

0,0	27	1 190	4,5	12,5	0,0	23,2	1 020	3,5	11	0,0	19,4	848	2,5	9	0,0	15,5	674	1,7	7,5
10,0	23,6	1 043	3,5	21	10,0	19,8	871	2,6	19,5	10,0	15,9	697	1,8	17,5	10,0	11,9	519	1,1	15,5
20,0	20,1	887	2,6	29,5	20,0	16,3	714	1,8	27,5	20,0	12,3	539	1,1	26	20,0	8,1	353	0,5	24

ELiS G-W-200

III step: V = 8100 m³/h

0,0	29,9	1 321	5,5	11	0,0	25,8	1 132	4,2	9,5	0,0	21,5	941	3,1	8	0,0	17,2	749	2,1	6,5
10,0	26,2	1 158	4,3	19,5	10,0	22	966	3,1	18	10,0	17,7	774	2,1	16,5	10,0	13,2	578	1,3	15
20,0	22,3	985	3,2	28	20,0	18	793	2,2	26,5	20,0	13,7	599	1,3	25	20,0	9	394	0,7	23,5

ELiS G-W-250

III step: V = 12000 m³/h

0,0	49,6	2 191	18,6	12	0,0	43	1 889	14,5	10,5	0,0	36,2	1 586	10,8	9	0,0	29,4	1 284	7,6	7
10,0	43,6	1 926	14,7	20,5	10,0	36,9	1 621	11	19	10,0	30,1	1 316	7,7	17,5	10,0	23,2	1 011	4,9	15,5
20,0	37,3	1 647	11	29	20,0	30,5	1 341	7,7	27,5	20,0	23,6	1 035	5	26	20,0	16,6	724	2,7	24

ELiS G-W-150 2R

III step: V = 6100 m³/h

0,0	60,1	2 654	3	29	0,0	51,5	2 263	2,3	24,5	0,0	42,7	1 869	1,7	20,5	0,0	33,6	1 467	1,1	16
10,0	52,2	2 306	2,3	35	10,0	43,6	1 918	1,7	31	10,0	34,7	1 522	1,1	26,5	10,0	25,4	1 107	0,7	22
20,0	44,1	1 944	1,7	41	20,0	35,4	1 555	1,1	37	20,0	26,4	1 155	0,7	32,5	20,0	16,0	700	0,3	28,0

ELiS G-W-200 2R

III step: V = 8800 m³/h

0,0	68,5	3 025	3,9	25,5	0,0	58,7	2 579	3	22	0,0	48,7	2 132	2,1	18,5	0,0	38,4	1 675	1,4	14,5
10,0	59,6	2 631	3	32,5	10,0	49,7	2 186	2,2	28,5	10,0	39,6	1 734	1,4	25	10,0	29	1 267	0,8	21
20,0	50,3	2 218	2,2	39	20,0	40,3	1 774	1,5	35	20,0	30,1	1 320	0,9	31,5	20,0	18,8	819	0,4	27

V – air flow
 PT – heating capacity
 Tp1 – inlet air temperature
 Tp2 – outlet air temperature

Tw1 – inlet water temperature
 Tw2 – outlet water temperature
 Qw – water flow in the heat exchanger
 Δpw – water pressure drop in the heat exchanger

CONTROL SYSTEMS

for ELiS air curtains



TS CONTROLLER basic version

Simplest regulation of 3-step fans. Fan heater operation is controlled by 3-step fan speed controller with thermostat.



T-box CONTROLLER BMS version

Intelligent regulation system of 3-step fans. Speed regulation of energy-efficient fan via T-box controller.



T-box Zone CONTROLLER BMS version with zones

T-box is an advanced intelligent touch screen controller with zoning function.

- controls up to 31 units or zones
- weekly programmer for each zone
- individual temperature setting for each zone

Luftridåer

ELiS

	TS Controller	T-box Controller	T-box Zone Controller
Controlling options			
Type of devices	Slim, ELiS T, ELiS B, ELiS G	Slim ⁽¹⁾ , ELiS T ⁽²⁾ , ELiS B, ELiS G ⁽¹⁾	ELiS AX
Manual 3-step air flow regulation	✓	✓	✓
Modes			
Heating/Ventilation	✓	✓	✓
Operation depending on door sensor and temperature	✓	✓	✓
Weekly programmer		✓	✓
BMS		✓	✓
Switch-off delay		✓	✓
Idle speed mode		✓	✓
INTEGRATION WITH FLOWAIR SYSTEM			
Weekly programmer for each zone		✓	✓
Individual setting for each zone			✓
Individual naming of each zone			✓
Antifreeze for each zone			✓
Max. number of connected units			
Via controller	ELiS T – 2, ELiS B – 5, Slim/ELiS G – 1	31	31
Via additional splitters	ELiS G – 9, Slim / ELiS T – 18	n/a	n/a
Type of fan			
AC – standard 3-step fan	✓	✓	
EC – standard			✓

⁽¹⁾ External control module DRV Slim required

⁽²⁾ External control module DRV ELiS required

CONTROL ELEMENTS

DOOR SENSORS



Door sensors inform the control system about the opening / closing of the door.

Compatibility of sensors with ELiS air curtains

Sensor	ELiS AX	Slim	ELiS T	ELiS B	ELiS G
DCet		✓	✓		
DCe	✓			✓	
DCm	✓		✓	✓	✓

VALVES SRQ



Two or three-way valves with an electric actuator are available to control the flow of the heating medium.

Compatibility of valves with ELiS air curtains

Valve	ELiS AX	Slim	ELiS T	ELiS B	ELiS G
SRQ2d 1/2"		✓	✓	✓	
SRQ2d 3/4"					✓
SRQ3d 1/2"		✓	✓	✓	
SRQ3d 3/4"					✓
SRX (0-10 V)	✓				

RX SPLITTERS



Control signal distributor for connecting several ELiS G air curtains with 3-stage fans to one controller.

The maximum number of devices supported by one controller

Splitter	Slim	ELiS T	ELiS G
1 pcs. RX	6 ⁽¹⁾	6	3
2 pcs. RX	12 ⁽¹⁾	12	6
3 pcs. RX	18 ⁽¹⁾	18	9

INSTALLATION ELEMENTS

CONSOLE

Console for vertical installation up to 2,5 meters. No possibility of joining curtains together.

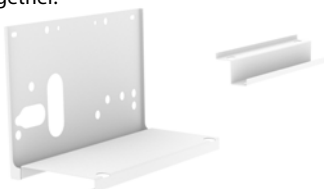

White brackets for horizontal installation.
 – up to 2 meters curtains - 2 brackets
 – 2,5 meter curtain - 3 brackets



BRACKETS Slim



Horizontal or vertical of the Slim available in black.

SYSTEM FLOWAIR

mini BMS at your finger tips

T-box
intelligent controller
with touch screen



LEO BMS
fan heaters



KM
mixing chamber

INTEGRATION OF DEVICES

SYSTEM FLOWAIR is an intelligent solution which makes it possible to integrate the devices into a system with only one controller. T-box offers many necessary functions for effective management of a heating-ventilating system. These function were previously reserved for an extensive Building Management System (BMS).



Control of devices with one T-box

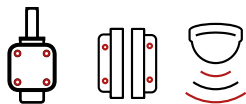

Local regulation of devices



Advanced control of ventilating and heating devices

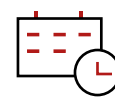

Control the devices according to your time schedule and individual needs



Antifreeze protects the devices against low temperatures



LEO D BMS
destratifiers

ELiS and Slim
air curtains

OXeN
ventilation unit with heat
recovery

I DELAY TIME AND IDLE SPEED

The function of the curtain off delay time allows the curtain to be automatically turned off after the set time has been counted down. The idle speed of the curtain allows the curtain to be set when the door is closed at reduced capacity for a pre-set time. After the set time has been deducted, the curtain is switched off.

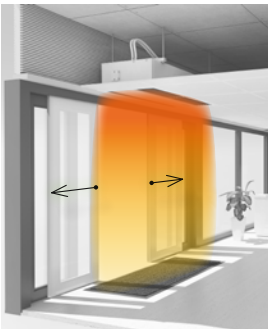

■ 3rd speed

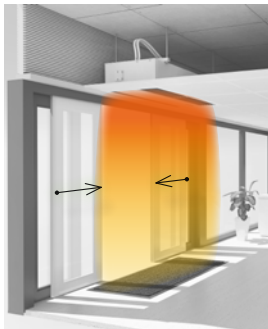

■ 3rd speed



■ 1st speed/ 1st minute

■ curtain idle speed

■ curtain delay time



FIND OUT MORE!
Get to know SYSTEM FLOWAIR - check how the curtain delay time and idle speed works.



ul. Chwaszczyńska 135
81-571 Gdynia

Tel. +48 58 627 57 20

for inquiries:
export@flowair.pl

