

DUPLEX

500 to 3500 Flexi-V

All-purpose ventilation units
with counterflow
heat exchangers – upright

The ventilation units of the new original patented DUPLEX Flexi-V design range are intended for comfort ventilation with the highest heat recovery efficiency and hot-air heating in all kinds of civil and residential buildings. They are made in five sizes: DUPLEX 500, 900, 1800, 2800 and 3500 Flexi-V.

The units are available in horizontal version for installation on the floor. In addition the unit sides may be interchanged, i.e. supply and exhaust air ports can be used conversely, allowing installation flexibility. The units can optionally be fitted with an integrated hot water heating coil or a chiller (water-based or direct), built-in electrical re-heater and electrical pre-heater. From the construction point of view all units are compact sets containing in a single cabinet two independently powered, highly efficient EC fans with flexibly mounted motors a counterflow high-efficiency heat recovery core with large heat-transfer area, a by-pass damper with an actuator, removable supply and extract air cartridge filters ePM10 50 % (M5) or ePM1 55 % (F7) and a condensate drain pan, all in the same housing. The front door enables easy access to all components. Inlet and outlet ports are rectangular. The housing is manufactured with white (RAL 9010) painted sheet metal panels with mineral insulation ($U = 1,23 \text{ Wm}^{-2}\text{K}^{-1}$). Units may be equipped with a complete control system, including a connection to the internet or to a third party management system – for detailed information see the section on controls.

DUPLEX Flexi-V ventilation units meet the requirements of the most stringent European standards:

- Casing properties according to EN 1886
- EC motors according to ErP 2015
- $\text{SFP} < 0,45 \text{ W}/(\text{m}^3/\text{h})$ according to Passive House Institute*
- Hygienic requests according to VDI 6022
- Commission regulation (EU) requirements No. 1253/2014 (Ecodesign)

Advantages of DUPLEX Flexi-V units:

- Great thermal insulation of the casing (class T2)
- Reduced thermal bridging (class TB2)
- High efficiency of fans – $\text{SFP} < 0,45 \text{ W}/(\text{m}^3/\text{h})^*$
- Multipurpose unit design
- Low power input – high EC fan efficiency
- High heat recovery efficiency thanks to new generation heat recovery exchangers – up to 93 %
- Low noise
- Possibility of additional installation of integrated heating and cooling coils (electric, water, DX)
- Ease of installation
- Integrated control system including temperature sensors
- Integrated web server (RD5 regulation)

* in the defined working area



500 to 3500 Flexi-V



OPERATING MODES OF DUPLEX FLEXI-V UNITS

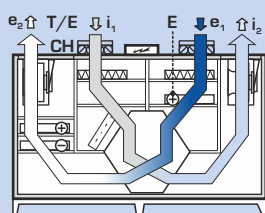

LEFT

Ventilation with heat recovery
with re-heating (with cooling)

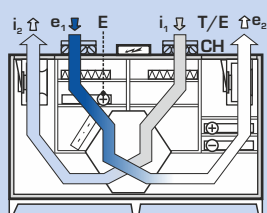

RIGHT

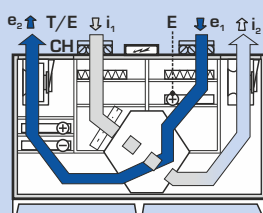

LEFT

Ventilation without heat recovery
(via bypass)

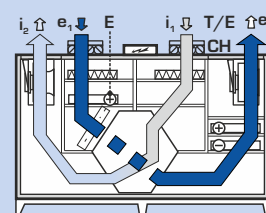

RIGHT

- ➔ e₁ ... Fresh outdoor air suction
- ➔ e₂ ... Fresh filtered air outlet

- ⇨ i₁ ... Exhaust air suction
- ⇨ i₂ ... Exhaust air outlet

- T/E ... Central heating / electrical heater connection
- CH ... Cooling connection

SELECTION SOFTWARE



For the detailed design of DUPLEX series units, accessories and control systems we recommend using our selection software. You can find it on our website at www.atrea.eu.



VENTILATION UNITS WITH HEAT RECOVERY

ATREA s.r.o., Čs. armády 32
466 05 Jablonec n. Nisou
Česká republika



Tel.: +420 483 368 133

Fax: +420 483 368 112

E-mail: atrea@atrea.eu

www.atrea.eu

PERFORMANCE GRAPHS

BASIC PARAMETERS

DUPLEX Flexi-V		500	900	1800	2800	3500
Air flow – max. ¹⁾	m ³ h ⁻¹	630	1 150	2 440	3 200	4 100
Recovery efficiency ²⁾	%	see curve				
Weight ³⁾	kg	148	187	409	518	581
Fan number	-	2	2	2	2	2
Power supply	V	230	230	230	230	400
Frequency	Hz	50	50	50	50	50
Max. power input	W	360	800	1 600	1 700	2 900
Fan speed	min ⁻¹	4 300	3 350	2 960	2 470	3 000
Heating output E pre-heater – max. ⁴⁾	kW	2,2	3,3	4,4	7,7	11
Heating output E re-heater – max. ⁴⁾	kW	2,2	3,3	4,4	7,7	11
Heating output HW – max. ⁴⁾	kW	4,5	11	18	26	36
Cooling output CD – max. ⁴⁾	kW	3	7	16	20	26
Cooling output CW – max. ⁴⁾	kW	2,5	6	15	17,5	22
Filtration class	-	ePM1 55 % (F7) / ePM10 50 % (M5)	ePM1 55 % (F7) / ePM10 50 % (M5)	ePM1 55 % (F7) / ePM10 50 % (M5)	ePM1 55 % (F7) / ePM10 50 % (M5)	ePM1 55 % (F7) / ePM10 50 % (M5)

¹⁾ Maximum flow rate through units at zero external pressure

²⁾ According to air volume

³⁾ Depending on equipment

⁴⁾ For detailed information please use our DUPLEX selection software.

PERFORMANCE SUMMARY

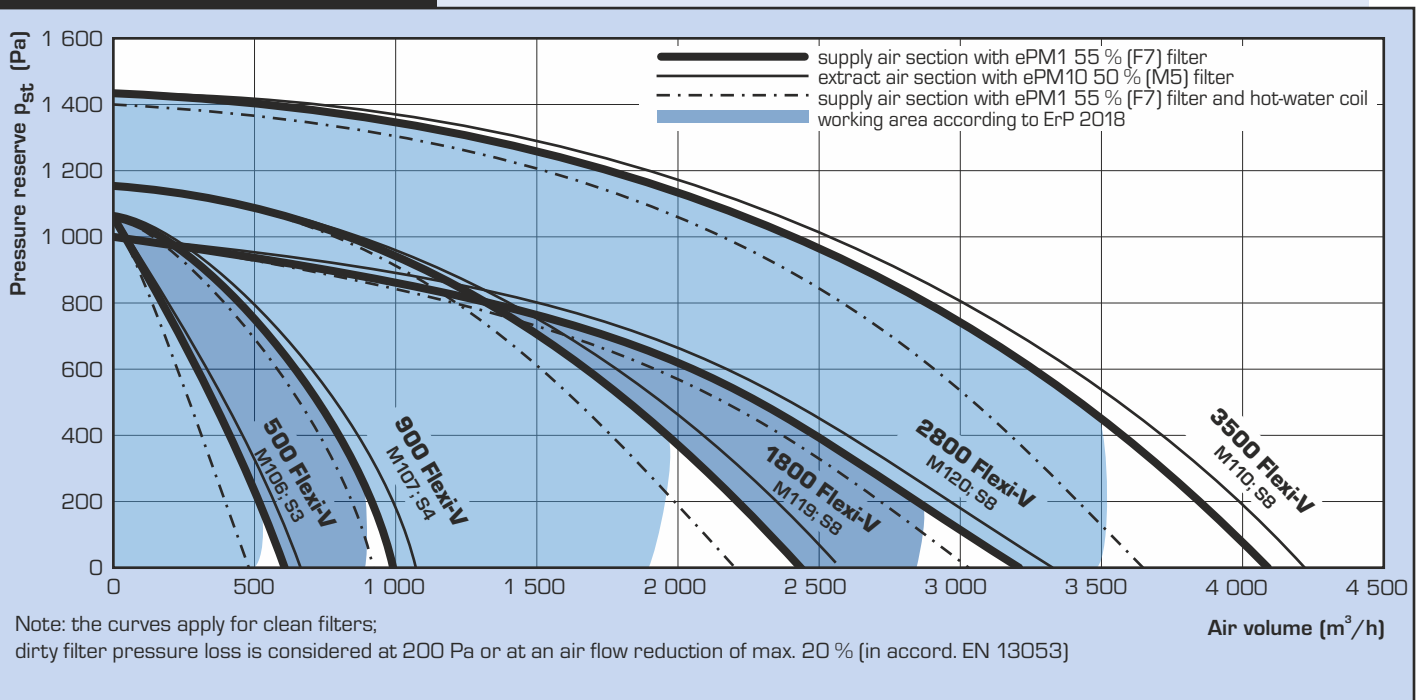

HEAT RECOVERY EFFICIENCY

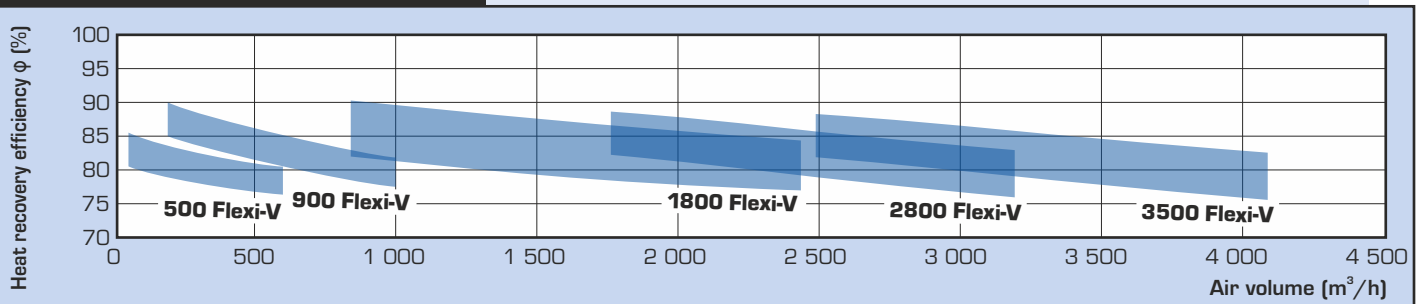

HEATING AND COOLING PERFORMANCES

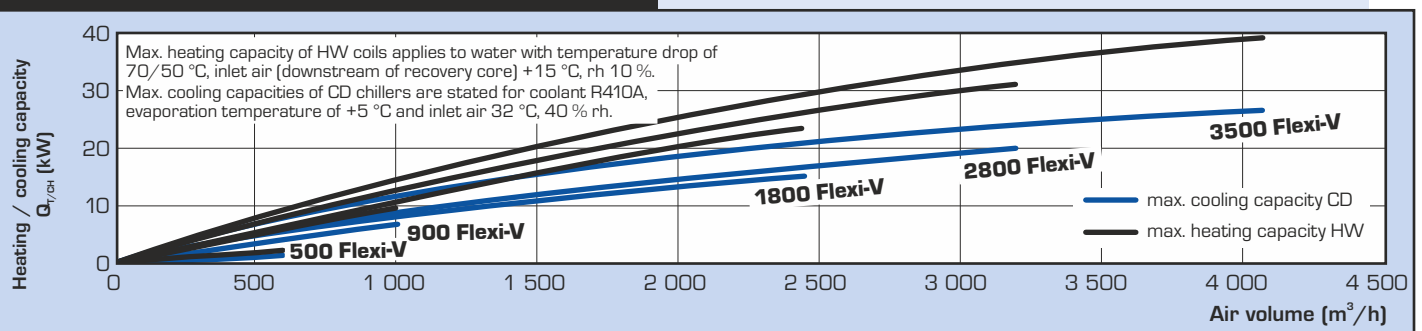

BASIC DIMENSIONS

UPRIGHT Flexi-V 500 to 3500

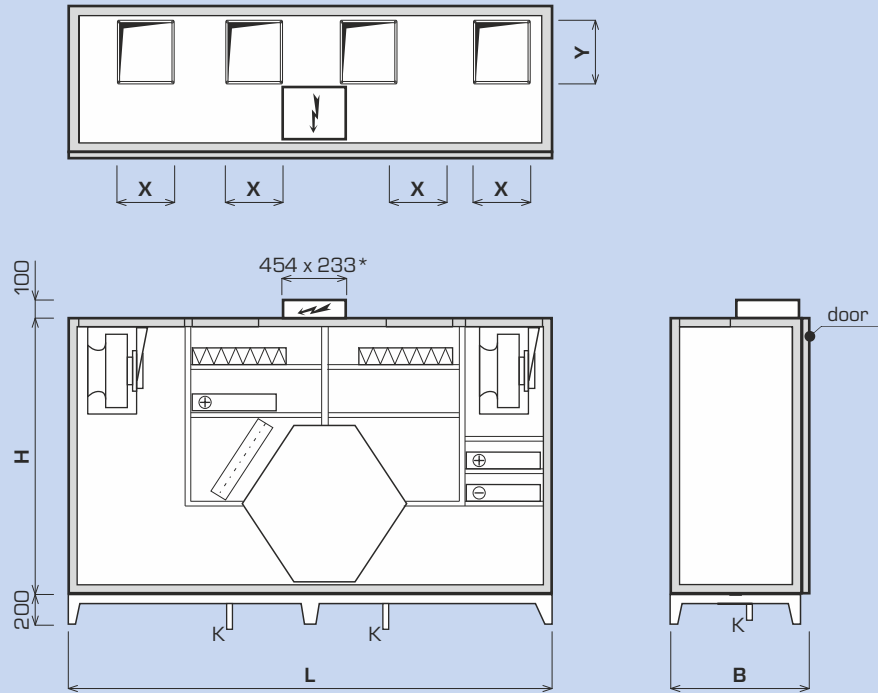

* For DUPLEX 500, 900 Flexi-V is 345×305 mm.

DUPLEX Flexi-V		500	900	1 800	2 800	3 500
Dimension H	mm	950	1 000	1 600	1 600	1 600
Dimension B	mm	615	700	725	1 100	1 290
Length L	mm	990	1 200	2 150	2 150	2 150
Condensate drain line	mm	$\varnothing 32$				
Connecting ports						
Dimension X × Y	mm	160×160	200×250	250×300	250×500	300×600

TYPES AND DIMENSIONS OF CONNECTING PORTS

Basic port
(inlet, outlet)

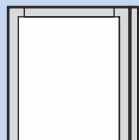

Port with flexible flange
(inlet, outlet)

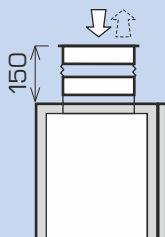

Port with damper
(inlet only)

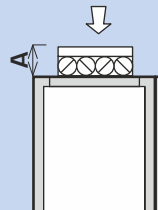

Port with damper and flexible flange
(inlet only)

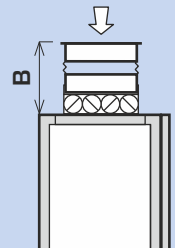

DUPLEX Flexi-V	A	B
500–900 Flexi-V	240	390
1800–3500 Flexi-V	110	260

For more detailed technical information check out ATREA selection software.

INSTALLATION AND VERSIONS

INSTALLATION VERSIONS AND CONNECTING PORTS

The units are available in multipurpose design - unit sides can be interchanged, i.e. supply and exhaust air ports can be used conversely. This ensures high installation flexibility on site. Each unit is fitted with several condensate drain pipes as standard. During installation the respective drain should be selected. The condensate drains used must be connected into a sewer system. The standard support steel legs are part of delivery.

All units are ready for additional installation of built-in heating and cooling coils. Following types of coils are available for Flexi-V:

- Electric pre-heater
- Electric heater
- Hot water heating coil
- Water-based chiller
- Direct evaporator (DX coil)

For a detailed unit design we recommend a special DUPLEX selection software be used; available at www.atrea.com.

MOUNTING POSITIONS

UPRIGHT POSITION Flexi-V 500 to 3500

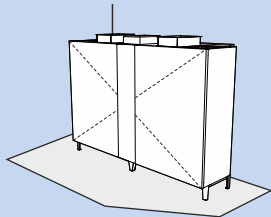

configuration 50/0 - door-side view

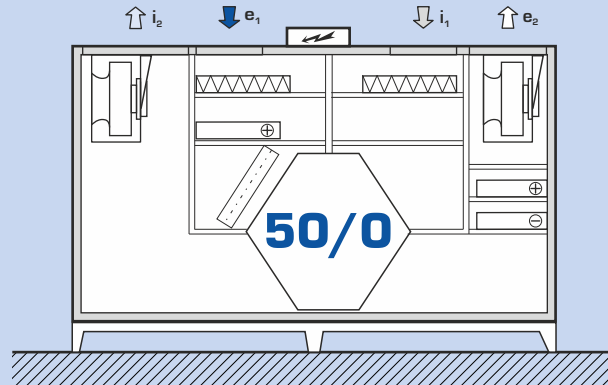

configuration 51/0 - door-side view

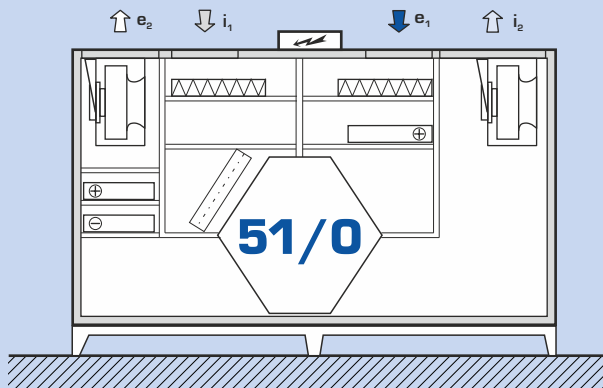

For more detailed technical information check out ATREA selection software.

OTHER CONFIGURATIONS OF DUPLEX FLEXI

FLOOR-STANDING

DUPLEX 1600-3600 Flexi

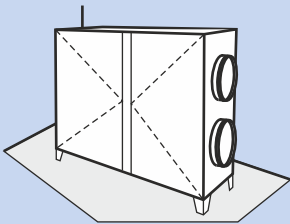

UNDER-CEILING

DUPLEX 1600-3600 Flexi

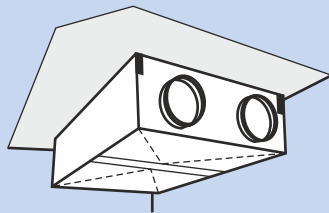

For detailed information please see separate technical catalogues.

HANDLING SPACE

DUPLEX units must be installed with the prescribed handling space around the unit in mind. Below the unit at least 150 mm must be left to install the DN 32 condensate drain line. This line must run through a U-bend at least 150 mm high into a sewer. This space is easily provided when the steel supporting feet supplied as standard are used. Handling space in front of the unit must be maintained for opening the front door, replacing filters and providing servicing and installation access to each unit part.

Each drawing shows the minimum handling space. In addition, each unit must have the minimum handling space of 600 mm from the side of the control system electric switchboard according to CSN.

Handling space in front of the door

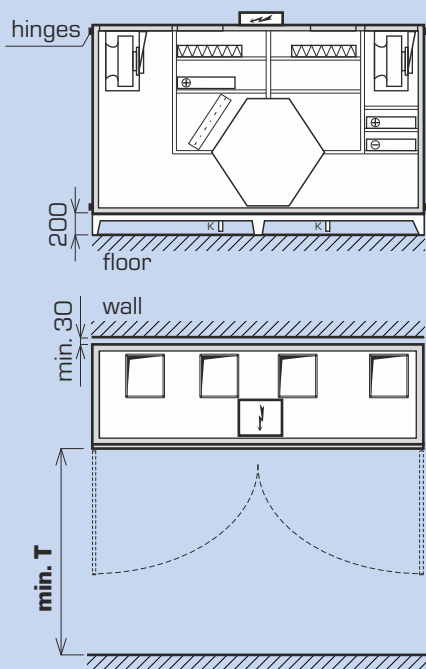

Handling space for accessories control modules

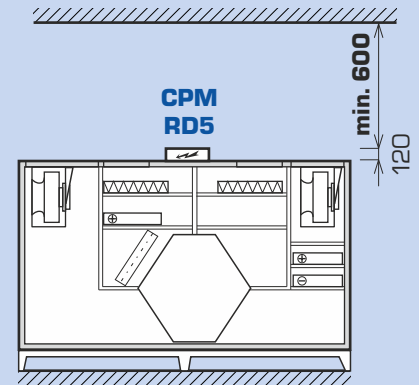

Type	standard door T [mm]
DUPLEX 500 Flexi-V	600
DUPLEX 900 Flexi-V	600
DUPLEX 1800 Flexi-V	1 100
DUPLEX 2800 Flexi-V	1 100
DUPLEX 3500 Flexi-V	1 100

ACOUSTIC POWER L_w AND ACOUSTIC PRESSURE L_{p_3}

Type	Working point	Acoustic power L_w [dB(A)]					Acoustic pressure L_{p_3} [dB(A)] at distance of 3 m
		inlet e_1	inlet i_1	outlet e_2	outlet i_2	unit	
DUPLEX 500 Flexi-V	400 m ³ /h (200 Pa)	50	46	70	67	47	27
DUPLEX 900 Flexi-V	800 m ³ /h (200 Pa)	52	53	74	75	59	38
DUPLEX 1800 Flexi-V	1 500 m ³ /h (200 Pa)	57	57	78	78	59	38
DUPLEX 2800 Flexi-V	2 500 m ³ /h (200 Pa)	55	55	83	83	65	44
DUPLEX 3500 Flexi-V	3 500 m ³ /h (300 Pa)	60	59	85	85	72	52

MODIFICATIONS

DUPLEX FLEXI-V - BASIC UNIT



Basic configuration

The compact unit consists of supply and exhaust centrifugal fans with electric motors in anti-vibration mounting, removable counterflow air-to-air heat recovery core assembled from thin plastic plates, removable ePM10 50 % (M5) or ePM1 55 % (F7) supply and exhaust air filters, and a condensate pan. A front door enables easy access to all built-in components and filters. The units meet requirement in accordance with Commission regulation (EU) No. 1253/2014 (Ecodesign) in the defined working area.

DUPLEX xxxx Flexi-V



Fans

All units are equipped with high-efficiency fans (ebm-papst and Ziehl Abegg) with impellers and backward curved blades in semispiral casing. Whole range of DUPLEX 500 to 3500 Flexi-V fans meets the requirements of the European directive ErP 2015.

Me.xxx; Mi.xxx

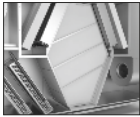

Heat recovery core

The units are equipped with a newly designed high-performance heat recovery core – type S8. This is made of thin plastic plates with high recovery efficiency up to 93 %.

S8

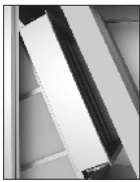

By-pass („B“)

The heat recovery core bypass, includes an actuator. When opening the by-pass damper, airflow through the recovery core closes automatically to avoid heat transfer.

B.x

DUPLEX FLEXI-V - OPTIONAL ACCESSORIES FOR ADDITIONAL INSTALLATION

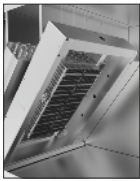

Electric heating coil

Integrated electric heating coils consist of PTC (Positive Temperature Coefficient) cells; they are generally used to heat up supply air. By default, electric heating coils always include protective thermostats (operational as well as emergency with manual reset) and regulation module, featuring power switching elements with so called "zero" switching function (SSR). For more information please refer to the selection software DUPLEX. An option delivered separately.

E.x

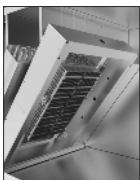

Electric preheater

Electric heating coils provide the antifreeze protection of the HR exchanger when equal-pressure ventilation is continuously required. Control is provided through the DUPLEX RD5 unit control system. For more information please refer to the selection software DUPLEX. An option delivered separately.

E.x

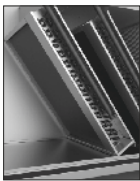

Hot water heating coil

Built-in water-to-air heating coil; made of copper pipes and aluminum fins. Designed for systems up to 110 °C and 1,0 MPa. Units with heating coil must be equipped with e, supply air shutoff damper; an actuator with spring-return function is recommended. An external coil hydraulic kit for heating capacity control of RE-HW.4 or RE-HW.3 type can be supplied with the coil upon request. For more information please refer to the selection software DUPLEX. An option delivered separately.

HW.x

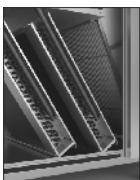

Direct expansion (DX) coil

A built-in coil made of copper pipes and aluminum fins with a special hydrophilic surface improving water drainage. For more information please refer to the selection software DUPLEX. An option delivered separately.

CD.x

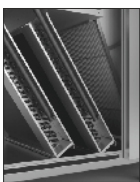

Chilled water cooling coil

A built-in coil made of copper pipes and aluminum fins with a special hydrophilic surface improving water drainage. The cooling coil can be equipped with the R-CW.3 external hydraulic kit on request. For more information please refer to the selection software DUPLEX. An option delivered separately.

CW.x

OTHER OPTIONAL ACCESSORIES (BASIC OVERVIEW)

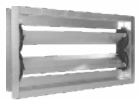

Shutoff damper e,; i,

Ke.xxx; Ki.xxx

Shutoff dampers are fitted on inlet ports. The dampers are available in different sizes based on unit ports and actuator types – the standard type is LM 24A and the type with spring return is LF 24 (to be shut off in case of power cuts). An option delivered separately.

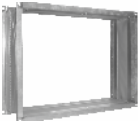

Flexible connection

H.P

Flexible connection for round or rectangular ports in the unit port sizes. An option delivered separately.



Control modes for water chillers

R-CW.3

Designed to control the cooling capacity of water chillers. The R-CW.3 with a 3-way fitting has a 3-way Belimo ball valve with a Belimo TR24-SR servo drive and two ball stop valves. An option delivered separately.



Heating coil hydraulic kit

RE-HW.4, RE-HW.3

Its function is to control heating capacity of a heating coil. It consists of a three-speed pump, two globe shutoff valves and connection pipes. Further equipment depends on the type:
 –RE-HW.4 – three-way mixing valve with an actuator for digital control system
 –RE-HW.3 – three-way diverting valve with a thermostatic valve for electric control system

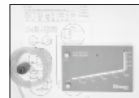

Tube manometers

A.MFF

Accessory for filters for simple view of current pressure drop. The tube manometers are obligatory for hygienic unit design in accordance with the VDI 6022. An option delivered separately.



Air filtration - two stage

Fe.xxx; Fi.xxx

The DUPLEX series may be optionally equipped with two stage filtration. The combination of ePM10 50 % (M5) / ePM1 55 % (F7) class is available for both (supply and exhaust) lines.



Air filtration

Fe.xxx; Fi.xxx

The DUPLEX series are equipped with filter cartridges as standard (ePM1 55 % (F7) / ePM10 50 % (M5) class filters – supply / exhaust). This filter combination fulfills hygiene requirements according to VDI 6022. Other filter combinations available are ePM10 50 % (M5) / ePM1 55 % (F7) and ePM1 55 % (F7) / ePM10 50 % (M5) / ePM1 55 % (F7).



Constant air flow and pressure

A.CF.XXX

Manometers reading fan pressure together with controls, enables intelligent fan control of preselected airflow. This accessory assumes the unit is equipped with RD5 digital control system.

DPT 2500

Using a second manometer (optional accessory) in the supply air duct enables the user to control constant pressure in the supply duct. An option delivered separately.

CONTROLS



DUPLEX Flexi-V units are delivered with basic control components or with complete control systems.

There are three types of control systems available (basic, CPM and RD5) according to customer needs and an application. The systems also include variety of sensors (temperature, humidity, air quality, CO₂) for effective operation control.

Features of the control systems

- selection of the most suitable and efficient control system at the lowest cost, depending on the particular application
- control system is integrated with the unit, most components are already wired and checked in factory, thus reducing the risk of incorrect wiring
- no control system project documentation is necessary for standard cases, standardized solutions can be used
- simple wiring, system simplicity, error indication
- qualified technical support and consulting

SUMMARY OF DUPLEX FLEXI CONTROL SYSTEMS

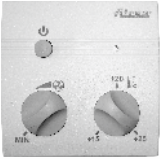
Type	Use	Controller
"Basic" controls	<ul style="list-style-type: none"> - all electrical components are wired to a junction box terminal strip inside or outside the unit - standard components are fans, damper actuators, capillary freeze protection thermostat of hot water heating coil - more components are included upon customer's request (exact actuator type, sensors, thermostats, pressure switches etc.) - suitable for applications with separate delivery of control system; e.g. large buildings with central control system etc. 	<div style="text-align: center;"> <div style="border: 1px solid black; padding: 5px; width: fit-content; margin: 0 auto;"> basic version (fans, actuators, thermostats, pressure switches and others on request) </div> <div style="text-align: center; margin: 5px 0;"> ↑ ↓ </div> <div style="border: 1px solid black; padding: 5px; width: fit-content; margin: 0 auto;"> Supervisory control system </div> </div>
"CPM" controls	<p>Standard functions</p> <ul style="list-style-type: none"> - EC fan speed control (stepless) - automatic by-pass damper position - frost protection of heat exchanger - switching of electric or water heater - input for external switch - inlet and outlet shut-off damper control - minimum and maximum fan speed preselection - analogue input (0-10 V) for air quality sensor (CO₂, RH) - outputs for controlling electrical preheater and heater (pulse switched 10 V) or water heater (controlled by 0-10 V signal) - outputs for controlling cooling (direct or water), eventually heat pump <p>Controller CPM</p> <ul style="list-style-type: none"> - fully graphic touchscreen - weekly program - „party" mode - „holiday" mode - filter change notice - automatic operation based on constant signal - e.g. constant pressure <p>Controller CP 10 RA</p> <ul style="list-style-type: none"> - rotatable controller 	<div style="text-align: center;">  <p>CPM controller with touchscreen display</p>  <p>CP 10 RA with mechanical knob</p> </div>
"RD5" controls	<p>Standard functions of the "RD5" controls</p> <ul style="list-style-type: none"> - EC fan speed control (based on selected mode) - automatic by-pass damper position (heat and cool recovery) - evaluates and prevents emergency limits based on measured temperature - ventilation and temperature weekly program setting - A web server and an Ethernet interface built in as standard connection for remote internet communication - inputs for switching using 230 V (4 inputs - 3 delayed, 1 instantaneous) - switch e.g. from bathrooms etc. - optional connection of CO₂ or RH sensor - max. 2 sensors with a switch or 0-10 V output - outputs for electric preheater and heater control (pulse 10 V) or hot-water control (0-10 V) <p>Additional RD-IO module</p> <ul style="list-style-type: none"> - optional manometer connection to ensure constant airflow control (see Constant airflow and pressure control on previous page) - constant pressure control - cooling control outputs (DX- or chilled-water cooling), possibly for a heat pump <p>Additional RD-K module</p> <ul style="list-style-type: none"> - additional inputs and outputs significantly extending control system functions <p>BACnet / KNX converter</p> <ul style="list-style-type: none"> - optional converter allowing connection to supervisory control system via BACnet or KNX protocol 	<p>CP Touch (touchscreen)</p>  <p>CP10RT</p>  <p>Web server (as standard)</p> 