

QUICK USER AND INSTALLATION MANUAL

Heat recovery unit Xhouse

Quick manual will guide you thru quick installation of the unit, but in any case, can not replace full manual. Full manual is available at our web page, www.xvent.cz or you can download it by QR code.



Check, that in the spot where you will install the unit, there are not any electric wires, water, waste or gas pipes, which you can brake during installation. Check, that the parameters of electric power network, you would like to connect the unit to, comply with requests of the unit (production label).



Make sure that the installation of the unit will not interfere the static of the building and comply with all safety legislative requests. Before starting the installation, check the possibility of connection to the sewage system for draining the condensate from the unit.

1) Použití jednotky

- The Xhouse unit is an air-conditioning device using ventilation technology with the recovery of heat (counter-current recovery exchanger) and humidity (enthalpy exchanger) with the option of automatic control of air output using AQS air quality sensors (accessories) or permanent ventilation - manual mode. The unit also has a burst ventilation mode - BOOOST, which is started either on the control panel or with an external switch EXT2 with a return flap, using e.g.: in the toilet, in the bathroom. The regulation of the unit also enables remote ON/OFF control using the external contact EXT1 or, with the help of the accessory (XCONT-HUB-0A0), control using the superior BMS system (modbus RTU protocol).

- The Xhouse unit also enables the fan offset function for use, for example: in buildings with a fireplace. Air output, running time of BOOST mode and fans offset can be adjusted separately in the customer menu.

- The unit can be used in spaces with a maximum nominal flow rate of approx. 300 m³/h (depending on the type).

- The unit is intended only for vertical installation on the wall.

- The unit is intended for indoor, covered and dry spaces with room temperature from +5 °C to +30 °C and with a maximum relative humidity of 70% non-condensing.



The supplied fresh air temperature from the outside environment can be in the range from -20 °C to +40 °C (applies to the version with preheating). If the temperature of the supplied air is lower than -20 °C, the unit may be automatically switched off to protect against possible damage.



Read the QR code by smart device enabling QR code reading.



2) Technical parameters

- Heat recovery exchanger - HRV

Heat recovery exchanger - HRV		XH1-30-ECS0HRXAS-0A0	XH1-30-ECS0HRPAS-0A0	XH1-30-ECS0HRXAS-1A0	XH1-30-ECS0HRPAS-1A0
Bypass version		Electronical		Mechanical	
Pre-heater		-	Electric	-	Electric
Nominal airflow* / BOOST**	m ³ /h	300 / 310		270 / 290	
Acoustic level***	dB(A)	43,3		42	
Weight****	kg	16,1	17,2	16	17
Power supply	V / Hz	1 ~ 230 / 50-60			
Nominal input* / BOOST**	W	184 / 195	784 / 795	180 / 182	780 / 782
Nominal current* / BOOST**	A	1,44 / 1,52	4,04 / 4,12	1,4 / 1,4	4 / 4
Thermal efficiency *****	%	81		80,5	
Electric safety	IP	20			
Energy class (ERP)		cold climate A+, middle climate A, warm climate A			

- Enthalpy recovery exchanger - ERV

Enthalpy heat and moisture exchanger- ERV			XH1-30-ECS0ERXAS-0A0	XH1-30-ECS0ERPAS-0A0	XH1-30-ECS0ERXAS-1A0	XH1-30-ECS0ERPAS-1A0
Verze bypassu			Electronical		Mechanical	
Vybavení jednotky - předeřev			-	Electric	-	Electric
Nominal airflow* / BOOST**	m ³ /h	290 / 300		260 / 280		
Acoustic level***	dB(A)	42,9		41,5		
Weight****	kg	16,6	17,7	16,5	17,5	
Power supply	V / Hz	1 ~ 230 / 50-60				
Nominal input* / BOOST**	W	182 / 192	782 / 792	178 / 179	778 / 779	
Nominal current* / BOOST**	A	1,42 / 1,5	4 / 4,1	1,4 / 1,4	4 / 4	
Thermal efficiency *****	Heat	75		74		
	Moisture	66		64		
Electric safety	IP	20				
Energy class (ERP)		cold climate A+, middle climate A, warm climate A				

* Nominal airflow (input, current) at external static pressure drop 150Pa

** BOOST mode - maximum intensive ventilation for set time period (ventilation intensity and time period is set in the user menu)

*** Acoustic pressure level in the free space in distance 3m (Q2) - 250m³/h - 120Pa

**** Weight of the unit without packaging

***** Recovery efficiency according to EN 308



- The unit must not be used to extract burning, glowing substances, flammable or explosive gases, aggressive media, liquids.
- The unit must not be installed close to the electricity socket, el. box, flammable materials, in environments with increased occurrence or risk of explosion, flammable substances, with increased dust and in environments with greater humidity, e.g.: bathrooms.
- Neither the manufacturer nor the supplier is liable for damages caused by incorrect use of the units. The risk is borne by the user.

3) Installation of Xhouse unit

- Minimum installation distances.

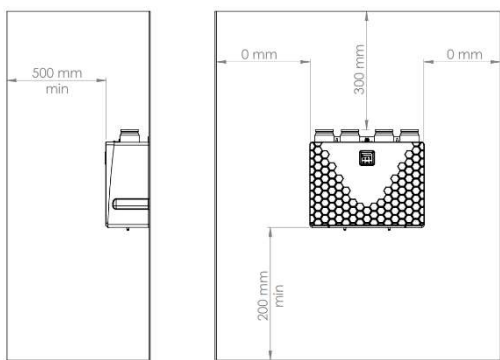

- Installation positions:

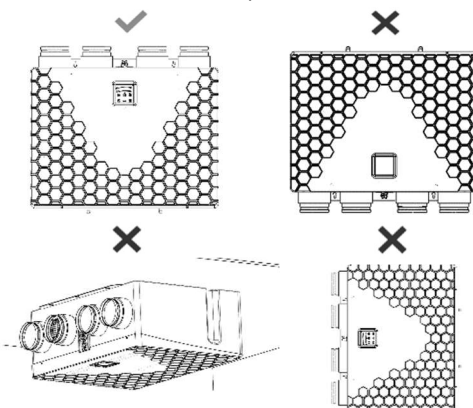

The Xhouse unit must be installed and put into operation in accordance with the general and locally valid safety regulations, by a person with adequate education, experience and knowledge of the relevant regulations, standards and possible risks and possible dangers, or by a suitably trained service technician. **Failure to follow the installation procedure may result in damage to the unit, malfunction, and possible injury to the user's health and property.**

- How to install Xhouse Unit

a) Remove the unit from its packaging

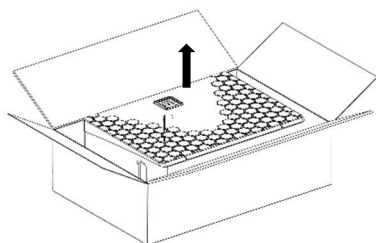

b) Align the anchor holes according to the dimensions on the unit, drill and hang the unit in the leveled when using suitable screws.

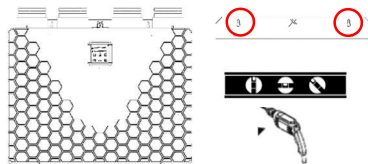

c) create a siphon by the hose and tie straps



d) choose the correct siphon position for connection to the

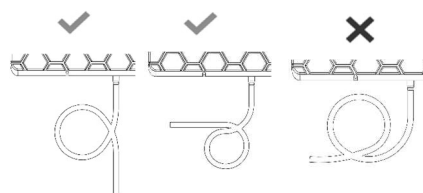

e) water the siphon, connect the hose to the outlet of the unit and secure with a strap

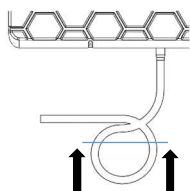

f) connect the siphon to the sewage system

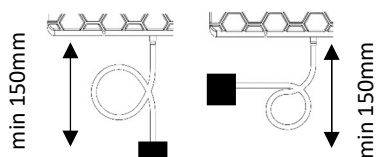

Before starting the unit for the first time or after a longer standstill, check the water trap. If you make a bend on the hose, pay attention to the correct bend radius to avoid "breaking the hose". To extend the siphon hose, always choose a hose - pipe of the same or larger diameter. Always choose the hose-pipe coupling with the smallest reduction of the inner diameter.

g) connect the air ducts to the Ø125mm nozzles according to the

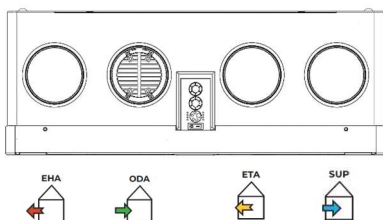

h) seal and insulate the joint - use the thermal insulation of the throats

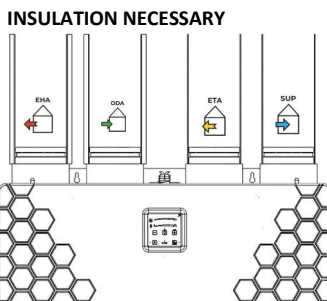

All pipe connections that are connected to the unit must be sufficiently sealed so that there were no unwanted leaks and subsequent problems, e.g.: condensation. the connected piping must be of the same diameter as the unit's connection sockets. If a pipe with a smaller diameter is used, it may affect the air performance of the unit and thus reduce the lifespan of the fans.

4) Electro installation – connection to the electric power network.



- Before starting any installation work, make sure that the wiring box or mains power socket you want to use to connect the unit is equipped with a protective (green-yellow) wire or contact (pin).
- If you use main plug to connect the unit, it must remain accessible at all times so that the unit can be safely disconnected from the mains in the event of an emergency.
- The relevant current circuit must be protected by a maximum of 16 A in the electrical power distribution.
- The electrical connection of the unit to the network may only be carried out by persons qualified for this activity with a valid authorization and knowledge of the relevant standards and directives.
- This unit belongs to the group of products with Y-type connection. If the power supply is damaged, it must be replaced by the manufacturer, its service center or a similarly qualified person in order to avoid a hazardous situation.
- The supply voltage to the unit 1~230V/50-60Hz must not be adjusted in any way, otherwise there is a risk of unit damage.

- Xhouse unit connection to the power network

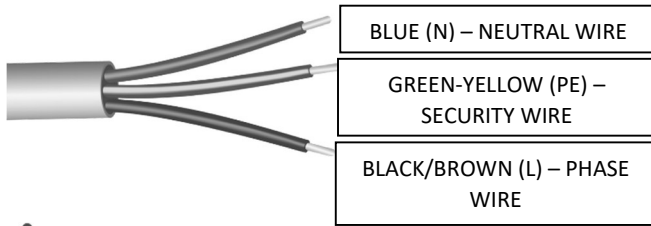

- Connection of the unit in to the electric box

- Input wire is ready from the manufacturer for connection in to the electric box.
- For connection of the income wire to the electric power network use appropriate components. (IE connectors, spring clamps)

- Connection of the unit to the electric socket

- Income wire is possible to connect with plug with security connector (pin) – this is not part of the delivery.



Installation of the income wire to the electric box or installation of the plug to the income wire and connection to the electric power network has to be performed only by authorised person and inline with safety law instructions valid in the area of the installation.

5) Controls – electro accessories to the Xhouse

- For the correct operation of the unit (in manual mode), there is no need to connect anything else. It is ready for immediate use after installation on the wall. For operation in automatic mode, you must connect the air quality sensor accessories CO2 (NL-ECO-CO2) or RH (NL-ECO-RH).

- Connection of electrical accessories

- Before connecting electrical accessories, always switch off the unit at the remote control and the main switch.

- Connect electrical accessories in the control box. To access the control box, proceed as follows:

a) loosen the securing screws of the design cover - remove the cover

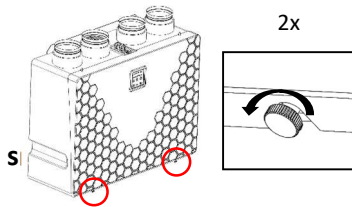

b) Unscrew the securing screw of the regulation box

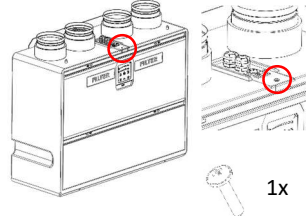

c) Unscrew 1x M6x20 screw on the sealing plate

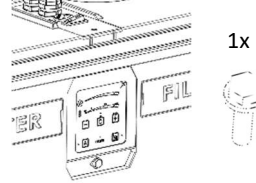

d) Remove the cover plate of the control box

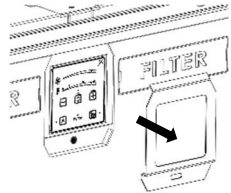

e) Using the textile tape, partially pull the control box out of the unit body. The control box can only be partially pulled out to allow access to the connection peripherals.

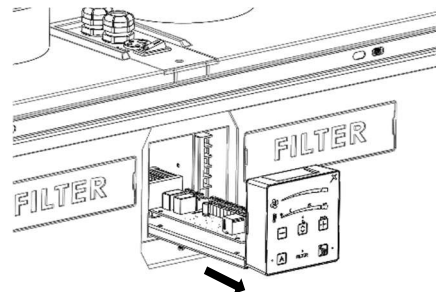

f) Loosen the grommet nut to secure the supply cable

g) Slide the sheet with grommets out of the rear groove

h) Push the sheet with the grommets to the side - into the longer groove

i) Pulling upwards, first flip out one side of the sheet with the grommets and then the other. This will release the entire sheet with grommets.

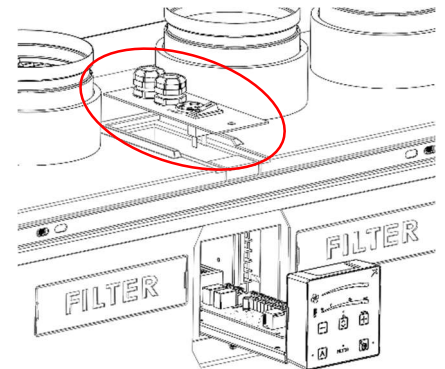

- Location of terminals in the control unit for connecting electrical accessories

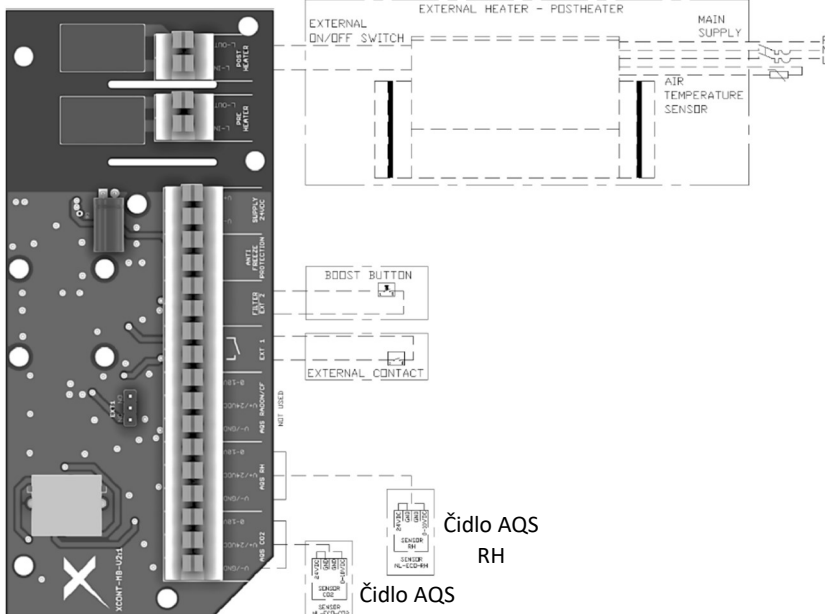

- Spring clamps with manual wire locking are used to connect the individual components. Both a licna-type conductor (cable with a sleeve) and a solid conductor (wire) can be installed in the terminals with a cross-section ranging from 0.5 to 1.5 mm², exposed length 10 mm. Before inserting the wire into the terminals, first press the locking orange button. Then insert the wire, release the lock and check that the wire is properly secured by pulling slightly on the clamp. If you need to remove the wire from the terminal, the procedure is the same. Choose the optimal conductor cross-section according to the length of the conductor route.

- Connection of CO2 (NL-ECO-CO2) and RH (NL-ECO-RH) sensors - AQS sensors (AQS CO2);

It is possible to connect 2x AQS sensors (1xCO2 and 1xRH) to the unit, which are used to measure the content of CO2 concentration and humidity – RH in the air at the place where the sensors are installed. Thanks to the sensors, it is possible to operate the unit in automatic mode, which automatically controls the operation and air output of the unit according to the current need in the given space where the sensors are installed. At the same time, this method of management is the most efficient in terms of economy of operation – it only ventilates as needed. If necessary, it is possible to connect up to 8 sensors of one type to the unit using the "PRO-SUM-08" accessory.

- Technical parameters of AQS sensors for connection to the unit

- o Power supply 24VDC
- o Analogue output 0- 10VDC
- o Max input 5W
- o Analogue input resistance 100kΩ

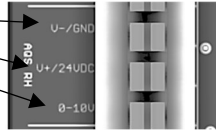

- Functionality of the unit for connecting AQS sensors

- The unit responds with continuous control to the need for ventilation triggered by the sensor in real time
- the switching concentration of the CO2 sensor is 800ppm, RH 65%
- cut-off concentration of the CO2 sensor is 700PPM, RH 60%



The supply GND is common with the Analog input GND. If the connection is not followed, there is a risk of destroying the control board

- External contact connection - EXT 1

- The regulation of the unit allows the connection of an external contact for remote switching on and off of the unit (remote ON/OFF control).
- The external contact is designed as potential-free, it can be switched by e.g.: magnetic contact, remote switch, time relay.

- Technical parameters of the external contact EXT 1

- o Switching voltage 24 VDC / 5mA
- o The contact can change the switching logic by switching the terminal bridge to NC or NO switching logic (factory setting).

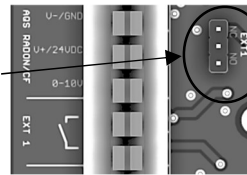
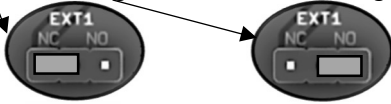

- Functionality of the unit when controlled by an external contact

- The external contact switches the unit on and off (same functionality as the ON/OFF button on the controller) with logical termination or activation of all running processes at the time of switching off, switching on.

- If the unit is turned on/off by an external contact, it can be turned off/on by the controller on the unit.

- External contact connection – EXT 2 - BOOST

- The controls allow the connection of an external button (flap switch with automatic return of the flap - e.g.: bell button with return spring) to start the shock ventilation mode for a set time - BOOST (hereinafter referred to as BOOST) for use e.g.: in the bathroom

- Technical parameters of the external contact EXT 2 - BOOST

- o Switched voltage 24 VDC / 5mA
- o The external contact is designed as potential-free
- o The factory setting is max. air output, run time 1 min.



- Functionality of BOOST mode

- An external switch turns on the BOOST mode at the set air output and run time. After the running time of the BOOST mode is over, the unit returns to the previous mode.
- To prematurely end the BOOST mode, hold the button for approx. 2 seconds. BOOST mode can also be turned on from the controller.

- Connecting the unit to the superior BMS system

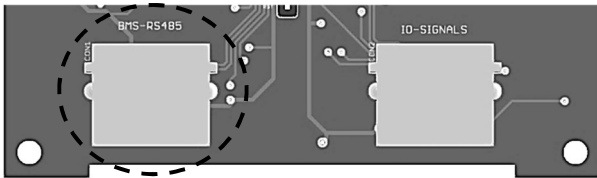

- The unit can be connected to a superior BMS system using the Modbus RTU communication protocol using the "XCONT-HUB" accessory.

- Connect the communication cable to the controller to the connector labeled BMS-RS485, connect the other end to the "XCONT-HUB" accessory to the connector labeled BMS-RS485.

- The description of the communication protocol is given in the separate document "D-502-xxx-Vxxx-xxx-MN-CENTRAL-MODBUS".

- Block diagram of the connection of the Xhouse unit

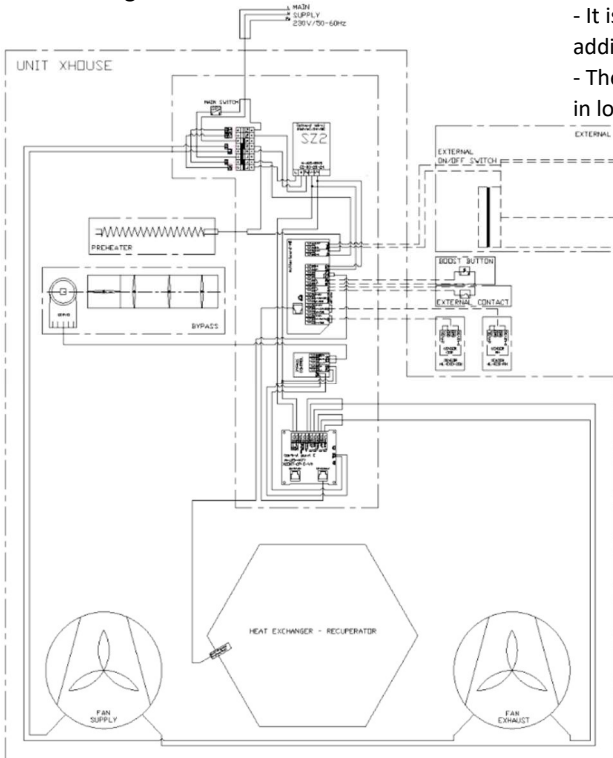

- Connecting an external electric postheater - POSTHEATER

- It is possible to connect an external electric heater (hereinafter referred to as an additional heater) with a maximum power of 1500W, voltage 1x230V to the unit.

- The unit switches only the supply phase – potential (L-IN) to the heater (L-OUT) in logic:

- o If the unit is ventilating, the phase is switched – the potential is closed
- o If the unit is standing, the phase is switched - the potential is open - the post-heating cooling function is active 3 min
- the unit's regulation cannot detect the presence/absence of reheating, therefore the reheating cooling function is always active.

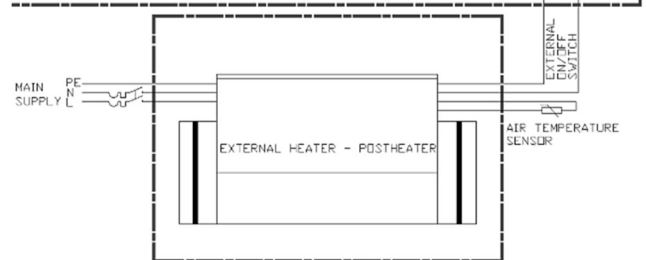

- Install the heater according to the manufacturer's instructions. The manufacturer of the unit is not responsible for incorrect installation and additional damages.