

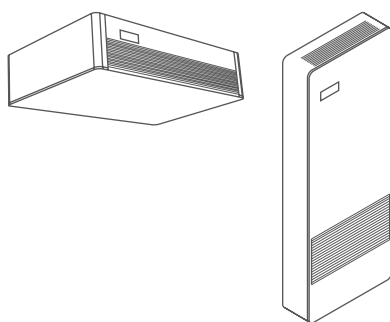

Fair

ASPIRCOMFORT PRO X

AIR EXCHANGE UNIT WITH HEAT
PUMP AND THERMODYNAMIC
RECOVERY



MORE HEALTHY ENVIRONMENT, ENERGY SAVING, CLEAN AIR RECIRCULATION

From the most recent evolutionary technologies and regulations in the field of construction emerge two main principles: limit consumption and improve the quality of the interior environment and hence its temperature, humidity and purity.

Today, with modern insulating materials for new generation systems, buildings need a constant air renewal, which forces us to open the windows frequently dispersing a considerable amount of thermal energy.

A practical solution?

The **Aspiricomfort Pro X** decentralised controlled mechanical ventilation (VMC/dMEV) units proposed by Aspira, the brand dedicated to air treatment by Fantini Cosmi Industrie, are perfect for **guarantee the right air exchange in small and medium-sized environments even in cases where large ventilation systems are not possible or necessary, or where it is perhaps not possible to create ducted systems.**



ALSO CONTROLS AIR QUALITY

Aspircomfort Pro X ventilation units also control the air quality to offer **well-being and comfort** in the indoor spaces.

INSTALLATION WITH FULL PEACE OF MIND

Easy and quick to install, the Aspircomfort Pro X VMC/dMEV units do not require additional air distribution systems and are installed directly on the external wall with only 2 holes on said wall, and a Shuko plug.

DESIGN AND SEMPPLICITY

The compact and elegant design of the Aspircomfort Pro X models is specifically designed for professional and commercial environments and wherever a good air exchange is required without the need to install more complex systems.

COMFORT IN EVERY SEASON

The Aspircomfort Pro X ventilation units are also equipped with a heat pump to ensure, in addition to **air renewal** and **thermodynamic heat recovery**, the **air conditioning of the incoming air**, able to satisfy the heating and cooling needs of the rooms.

COVID-19

THE IMPORTANCE OF VENTILATION TO PREVENT INFECTION



Air renewal in rooms is one of the countermeasures recommended by the ISS to reduce the likelihood of contagion from COVID-19.

While up until last year the main topics in terms of dwellings were sustainability, energy savings and smart home, the pandemic has suddenly changed the paradigm by introducing, at least in the short and medium term, a new issue, i.e. that of protection against infection and pathogens.

Among the main concepts dedicated to public areas or however open to the public, technologies intended for automatically measuring temperature and disinfection with UV rays stand out.

Improving natural indoor ventilation (where the air quality allows for this) or using mechanical ventilation systems with air quality control and management also offer an important aid. This makes it possible to have clean air free of pollutants and bacteria.

As we have seen, one of the main indications concerns air quality management through ventilation. After all, this guideline has already been provided by the Italian national Higher Health institute (ISS) and is applied conveniently and efficiently in controlled mechanical ventilation (VMC/MEV).



AICARR FAVORABLE JUDGEMENT

AICARR (Italian association of air conditioning-heating and cooling) has conveyed its favorable judgement regarding use of MCV towards COVID risks reduction by releasing some guidelines how to better use and maintain an MCV installation. It is about a recommendation included in no 33/2020 report by Istituto Superiore della Sanita regarding application and efficiency in MCV systems both in residential or collectivity environments.

Here below main points:

“MCV installation should be working continuously and well controlled. Microclimatic parameters (ex.temperature, humidity,CO2) must be monitored.”

Furthermore it is advisable:

- To clean regularly ventilations and outlet grilles with water and soap or with ethyl alcohol 75%;
- to clean regularly the filters and use efficient filters



ASPIRCOMFORT PRO X

the **ready-for-use** solution
ideal for exchange,
sanitation and air
conditioning

Fantini Cosmi, with its own brand Aspira, offers a wide and complete range of VMC solutions able to satisfy the markets needs, from small to large rooms. Among **most rapid solution to fight indoor pollution** ASPIRCOMFORT PRO X suitable for **exchange and sanitation** (with accessory) **of the air**; it uses a thermodynamic heat recovery bringing a significant advance in energy saving.

Aspiracomfort Pro X is a decentralized ventilation unit equipped with heat pump with cooling circuit and high efficiency thermodynamic recuperator to transfer energy from exhaust to incoming air, able to reach **efficiency over 90%**.

Thanks to used components and manufacturer peculiarities, Aspiracomfort PRO X is suitable for air exchange, heat recovery and climatization integration, **able to satisfy heating and cooling requirements** in the used installations.



High flow capacity, allows application in several buildings: **residential, schools, offices** and whenever is necessary air exchange with sanitized air.



Indoor pollution can be up to 5 times higher*
than outdoor pollution

A VALID COUNTERMEASURE AGAINST EPIDEMICS

Air renewal in the environments is one of the countermeasures recommended by the ISS - Istituto Superiore di Sanità (Italian National Institute of Health) to reduce the likelihood of contagion from COVID-19. A recent report stated that all confined spaces where people live should be provided with an adequate air renewal.

* Source: SOCIETÀ ITALIANA DI MEDICINA AMBIENTALE

DUAL FLOW AIR RECIRCULATION

The Aspircomfort ventilation units are controlled by a Brushless motor with directly coupled electronic motor and modulating control that makes it possible to obtain maximum comfort with lower consumption and more silent operation. The fans are mainly controlled by CO₂, VOC, temperature and humidity sensors placed inside the unit which regulate its automatic operation.

ASPIRCOMFORT PRO X 380V
Decentralised ventilation unit
with vertical installation

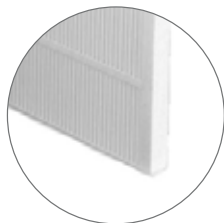
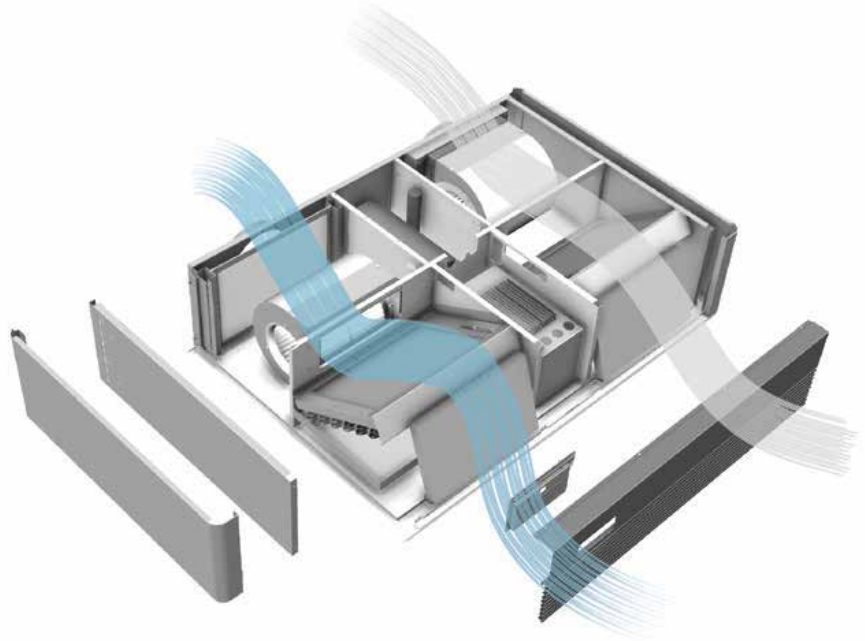

The air is also constantly filtered through ePM1 80% filters that are easily removable for periodic cleaning.

The continuous use of the unit helps prevent dampness, the formation of mould on the walls and maintains a constantly low level of pollutants.



INDOOR AIR QUALITY SENSORS

In Aspira ventilation systems, the temperature, the relative humidity (RH%), the concentration of carbon dioxide (CO₂) and volatile organic compounds (VOC) is constantly monitored by the on-board sensors of the device which, based on the values detected, adjust the fresh air flow rate according to real needs.

**VERY HIGH
RECOVERY
EFFICIENCY
> 90%**

Active thermodynamic recuperation allows to recover energy from exhaust air, via a dedicated cooling circuit. This allows to recover the heat from exhaust air to transfer it to incoming air in order to obtain the desired ambient temperature by **helping climatization installation**. This for summer cooling too.

The complete and safe separation between the extracted indoor air and the supplied outdoor air gives the units **greater thermal efficiency and better filtration of the supplied air**.

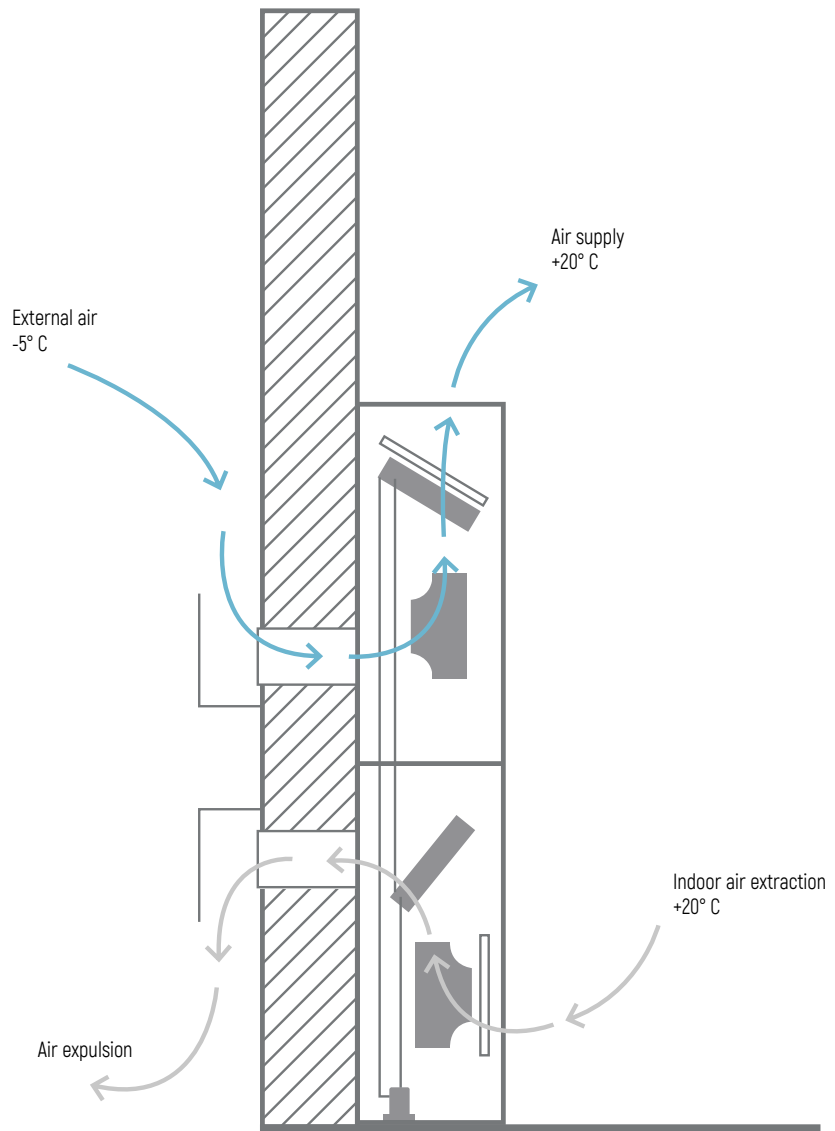

Operation diagram
ASPIRCOMFORT PRO X 460H
Decentralised ventilation unit
with horizontal installation.

EASY TO INSTALL

The unit is complete with every component for its operation and **ready for use**. Installation is easy and economical as doesn't requires additional distribution air system for exhaust or air immersion, it is done **directly on the perimetric wall** through **2 holes of 162mm diameter**.

Unit is equipped with power supply cancel with **schuko plug**.

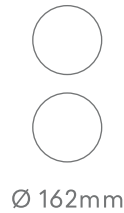

1. Drill 2 holes in the perimetric wall



2. Place the unit

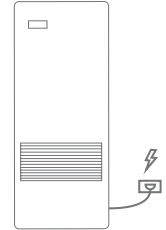

3. Connect power supply

COMPACT DESIGN AND SEMPLICITY

ASPIRCOMFORT PRO X thanks to its **compact design** suit very well professional or commercial ambients, whenever is required a good air exchange without heavy installation works.

Electrical panel on board the unit with microprocessor and dedicated infrared **remote control** allow fans management with air quality probe, display and temperature setpoint, timed dirty filter management.

ASPIRCOMFORT PRO X is available in 2 models:

-PROX460H for cieling installation

-PROX380V for vertical installation (just 18mm thickness)

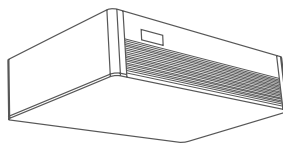

ASPIRCOMFORT PRO X 460H
Decentralised ventilation unit
with horizontal installation.

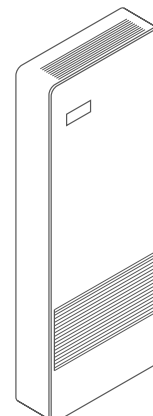

ASPIRCOMFORT PRO X 380V
Decentralised ventilation unit
with vertical installation

AIR QUALITY AND SANITISATION

The Aspircomfort Pro X units are designed to be equipped with the UV-C lamp (as accessory) that provides a germicidal action on the air coming in from outside. The lamp is activated **automatically based on the room air quality**. This feature makes Aspircomfort PRO X particularly suitable also for example in **medical and dental offices as well as school classrooms** and any other facility with high traffic where you want to keep the air sanitised.

In addition, Aspircomfort Pro X also controls the air quality through the sensors on the machine. Temperature, relative humidity (RH%), concentration of carbon dioxide (CO2 equivalents) and volatile organic compounds (VOC) are constantly monitored by the sensors of the environment control device CH193VMC which, based on the values detected, **adjust the fresh air flow rate according to real needs**.



UV-C SANITISATION BENEFITS

- It allows to carry out a germicidal action on the air introduced from the outside through the effect of UV-C ultraviolet radiation preventing mold formation and inactivation of bacteria and virus;
- Prevents infective sickness caused by virus and bacteria.
- It keeps cleaned unit components, as batteries, condensate drain, plenum and pipes, avoiding to use dangerous chemical products.
- It doesn't harm health, do not produce ozone or others elements;
- It doesn't harm people and other appliances in the treated ambient.

ASPIRCOMFORT PRO X 460H



- For commercial applications, schools, offices
- Very high recovery efficiency >90%
- Heat pump
- Horizontal installation
- Unit complete and ready for use
- UV-C lamp (optional)
- Power supply cable with Shuko plug

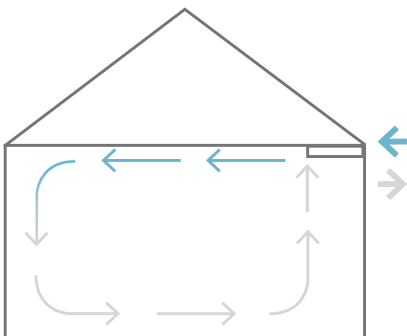

AP20068 - Decentralised ventilation unit with horizontal installation, equipped with heat pump and thermodynamic recovery.

Aspircomfort PRO X is a unit designed for the renewal and sanitisation of the air of medium-small rooms. This solution is capable of independently integrating the ventilation requirements and integrating the cooling thermal requirements of the served rooms.

The high fresh air flow rate allows the application in situations such as residential buildings, schools, surgeries, offices and all contexts where air exchange is required. The unit is designed to be equipped with the UV-C lamp that provides a germicidal action on the air coming in from outside. The lamp is activated **automatically based on the room air quality**. For example, this feature makes Aspircomfort PRO X particularly suitable also for **medical and dental offices as well as school classrooms** and any other facility with high traffic where you want to keep the air sanitised.

The **thermodynamic recovery** allows for integration according to the environmental climatic conditions, helping the air conditioning system fulfil the demand with a temperature close to or better than the room temperature, thus ensuring a higher perceived comfort.

The panel with graphic interface and remote control included allows fan management with air quality probe, temperature display and setpoint, timed dirty filter management.

The unit is composed of a monoblock which includes every component for correct operation and is ready for use. Installation is therefore simplified and economical as it does not require additional air distribution systems (pipes and fittings), neither for input nor output, and is installed directly on the external wall by two holes with a 160 mm diameter.

HOMOLOGATION AND STANDARDS

The CE marking (applied on each machine) certifies compliance with the following Community standards:

- Low Voltage Directive 2014/35/EC
- Electromagnetic Compatibility Directive 2014/30/EC

CE EAC

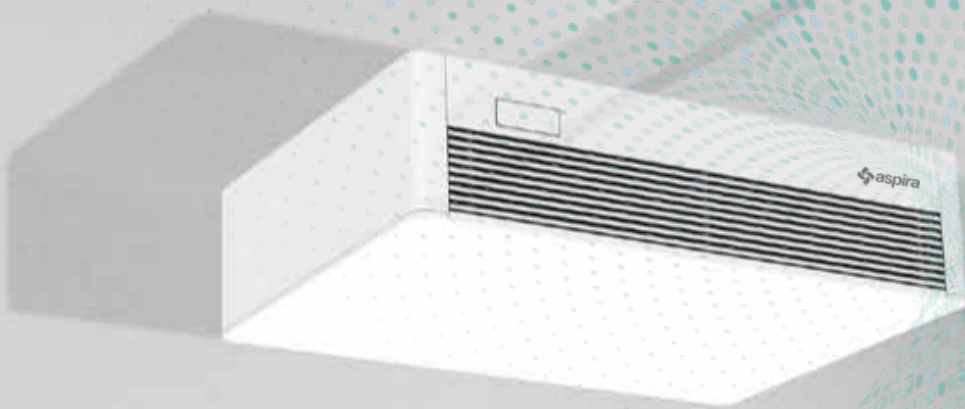

AP20068

TECHNICAL FEATURES

TOTAL FLOW RATE	m ³ /h [@100 Pa]	460
RENEWED AIR FLOW RATE	m ³ /h [@100 Pa]	460
SPI	W/(m ³ /h)	0.26
SOUND PRESSURE LEVEL [1m]	dB(A)	50
SOUND PRESSURE LEVEL [3m]	dB(A)	43
PROTECTION RATING	IP	X0

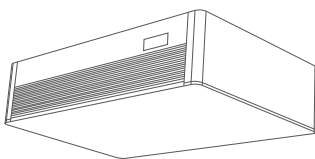

DIMENSIONS [mm]

Width L	mm	1010
Depth P	mm	690
Height H	mm	255
DN Outdoor air/ exhaust	mm	162
Condensation	∅ mm	20
Weight	kg	74

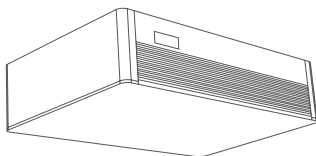

Front view

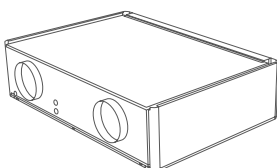

Rear view

GENERAL SPECIFICATIONS

- Centrifugal fans with constant flow, with directly coupled brushless electronic motor and modulating control.
- The inverter refrigeration unit allows active recovery of energy from the exhaust air. The thermodynamic recovery allows, thanks to its cooling circuit, to supply energy to the environment in a higher quantity than that taken away by the ventilation for 90% of the unit's operation.
- EPM1 filter placed after the coil to completely filter out any impurities in the supplied air. On the outdoor air there is a Coarse pre-filter that protects the cleanliness of the unit.
- Self-supporting sheet metal frame. Self-supporting sheet metal structure, externally painted (in the visible versions), with polyethylene and EPDM thermal and acoustic insulation in between.
- Cooling circuit made of brazed copper complete with high-efficiency BLDC compressor, filter dryer, finned coils, electronic expansion valve, reversing valve and safety devices.
- Electric panel on-board the unit with microprocessor and dedicated regulation.
- Fan management with air quality probe, temperature display and setpoint, timed dirty filter management. Panel with graphic interface and remote control included.
- The unit is designed to be equipped with the UV-C lamp (cod. AP20384) that provides a germicide action on the air supplied from outdoors. The lamp is activated automatically based on the room air quality.



ASPIRCOMFORT PRO X 380V



AP20069 - Decentralised ventilation unit with vertical installation, equipped with heat pump and thermodynamic recovery.

Aspircomfort PRO X is a unit designed for the renewal and sanitisation of the air of medium-small rooms. This solution is capable of independently integrating the ventilation requirements and integrating the cooling thermal requirements of the served rooms.

The high fresh air flow rate allows the application in situations such as residential buildings, schools, surgeries, offices and all contexts where air exchange is required. The unit is designed to be equipped with the UV-C lamp that provides a germicidal action on the air coming in from outside. The lamp is activated automatically based on the room air quality. For example, this feature makes Aspircomfort PRO X particularly suitable also for **medical and dental offices as well as school classrooms** and any other facility with high traffic where you want to keep the air sanitised.

The thermodynamic recovery allows for integration according to the environmental climatic conditions, helping the air conditioning system fulfil the demand with a temperature close to or better than the room temperature, thus ensuring a higher perceived comfort.

The panel with graphic interface and remote control included allows fan management with air quality probe, temperature display and setpoint, timed dirty filter management.

The unit is composed of a monoblock which includes every component for correct operation and is ready for use. Installation is therefore simplified and economical as it does not require additional air distribution systems (pipes and fittings), neither for input nor output, and is installed directly on the external wall by two holes with a 160 mm diameter.

- For commercial applications, schools, offices
- Very high recovery efficiency >90%
- Heat pump
- Vertical installation
- Unit complete and ready for use
- UV-C lamp (optional)
- Power supply cable with Shuko plug

HOMOLOGATION AND STANDARDS

The CE marking (applied on each machine) certifies compliance with the following Community standards:

- Low Voltage Directive 2014/35/EC
- Electromagnetic Compatibility Directive 2014/30/EC

CE EAC



 aspira

AP20069

TECHNICAL FEATURES

TOTAL FLOW RATE	m ³ /h [@100 Pa]	380
RENEWED AIR FLOW RATE	m ³ /h [@100 Pa]	380
SPI	W/(m ³ /h)	0.245
SOUND PRESSURE LEVEL [1m]	dB(A)	48
SOUND PRESSURE LEVEL [3m]	dB(A)	41
PROTECTION RATING	IP	X0

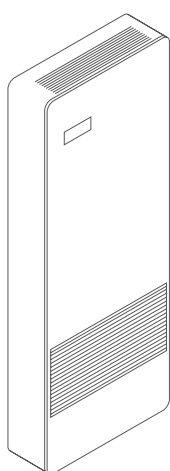

DIMENSIONS [mm]

Width L	mm	500
Depth P	mm	185
Height H	mm	1398
DN Outdoor air/ exhaust	mm	162
Condensation	∅ mm	20
Weight	kg	53

GENERAL SPECIFICATIONS

- Brushless plug-fans with directly coupled electronic motor and modulating control.
- The inverter refrigeration unit allows active recovery of energy from the exhaust air. The thermodynamic recovery allows, thanks to its cooling circuit, to supply energy to the environment in a higher quantity than that taken away by the ventilation for 90% of the unit's operation.
- EPM1 filter placed after the coil to completely filter out any impurities in the supplied air. On the outdoor air there is a Coarse pre-filter that protects the cleanliness of the unit
- Self-supporting sheet metal frame. Self-supporting sheet metal structure, externally painted (in the visible versions), with polyethylene and EPDM thermal and acoustic insulation in between.
- Cooling circuit made of brazed copper complete with high-efficiency BLDC compressor, filter dryer, finned coils, electronic expansion valve, reversing valve and safety devices.
- Electric panel on-board the unit with microprocessor and dedicated regulation.
- Fan management with air quality probe, temperature display and setpoint, timed dirty filter management. Panel with graphic interface and remote control included.
- The unit is designed to be equipped with the UV-C lamp (cod. AP20384) that provides a germicide action on the air supplied from outdoors, through the effect of the UVC. The lamp is activated automatically based on the room air quality.

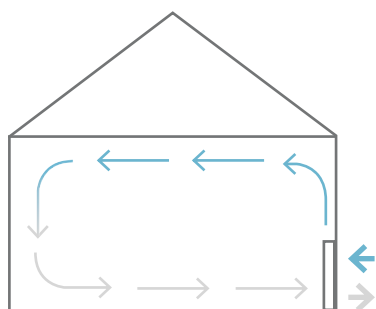



The features referring to the equipment in this catalogue are not binding. The company Fantini Cosmi S.p.A. reserves the right to make changes without prior or public notice for technological improvement, regulatory evolution and commercial matters, without prejudice to the main functional features of the models.



FANTINI COSMI SPA Via dell'Osio, 6 - 20049 Caleppio di Settala MI, Italy
Tel. +39 02 956821 | Fax +39 02 95307006 | info@fantinicosmi.it

EXPORT DEPARTMENT
Ph +39 02 95682229 | Fax +39 02 95307006 | export@fantinicosmi.it

www.fantinicosmi.com

