

Kelvion

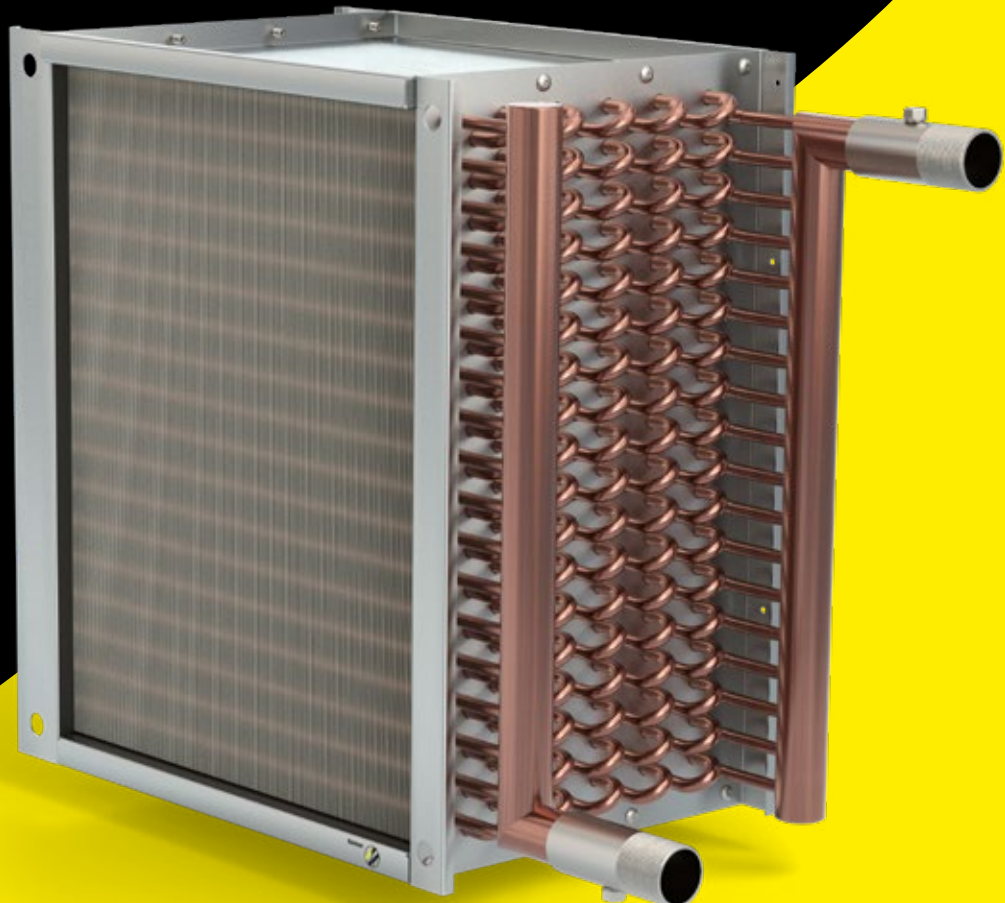

Product Line: Coils

LEADING-EDGE PRODUCTS FROM INNOVATION AND EXPERIENCE



Kelvion

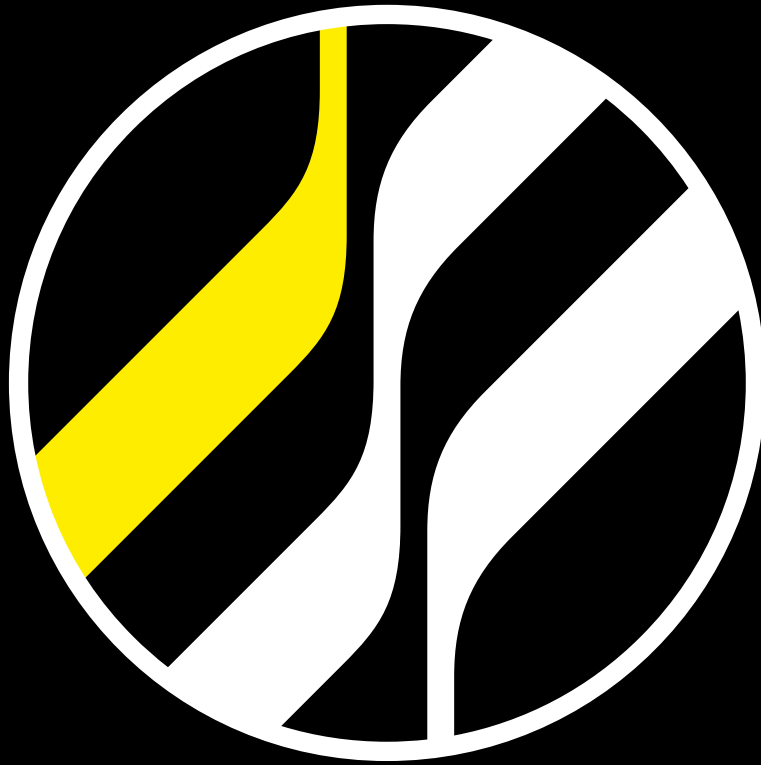

EXPERTS IN HEAT EXCHANGE – SINCE 1920

Welcome to Kelvion! Where Heat Exchange is our Business. We are one of the leading global manufacturers of heat exchangers and have been providing solutions for almost every industrial application imaginable since the 1920s, specializing in customized solutions suitable for extreme environmental conditions - as of 2015 under the name of Kelvion.

With one of the most extensive selections of heat exchangers in the world, we are a well-known partner in many industries, including transportation, energy, oil and gas, chemical, marine as well as food and beverage, data center and the HVAC and refrigeration technology sector. Our products include Compact Fin Heat Exchangers, Plate Heat Exchangers, Single Tube Heat Exchangers, Transformer Cooling Systems, Cooling Towers and Shell & Tube Heat Exchangers.

Our many years of experience and in-depth expertise have made us specialists in this field. Our heat exchangers are designed specifically to meet the needs of the respective machine or equipment system, ensuring outstanding energy efficiency and reliability in any market segment. This gives our customers a cutting-edge over their competitors while also reducing operating costs over the long term.

As your heat exchange partner, we understand that outstanding and reliable after-sales services are critical for you, our customer, and we work alongside with you in close partnership supporting you throughout the full life cycle of your plant and equipment to ensure lasting business success.

Kelvion – Experts in Heat Exchange.

KELVION – A TRIBUTE TO LORD KELVIN (1824 - 1907)



Lord Kelvin formulated the laws of thermodynamics and absolute units of temperature are stated in kelvin, in his honor.

OUR LOGO – INSPIRED FROM THE SCHEMATIC FOR HEAT EXCHANGER

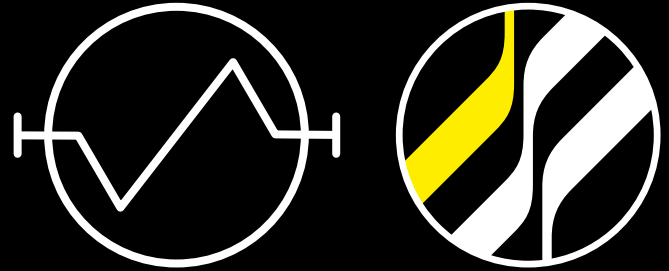

67 BRANCHES AND SALES PARTNERS WORLDWIDE

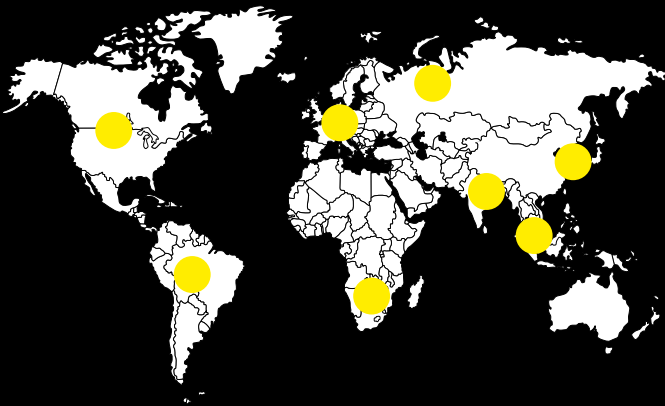

5,000 EMPLOYEES WORLDWIDE

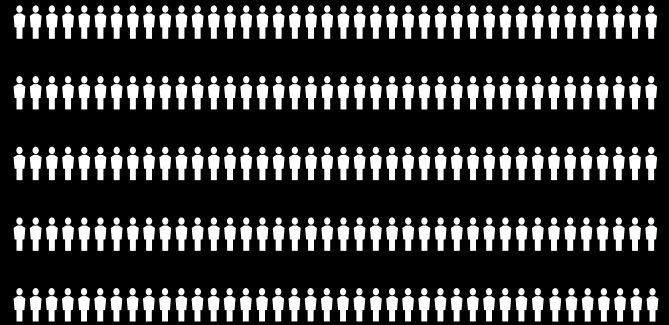

YOUR MARKETS ARE OUR MARKETS

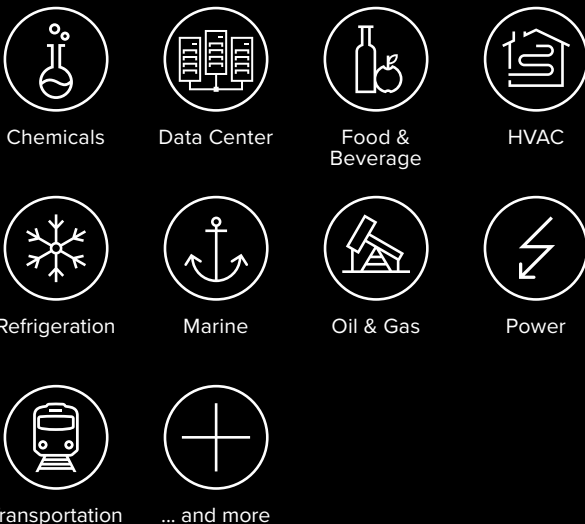

KELVION HAS A LONG HISTORY



APPLICATIONS



HVAC



REFRIGERATION

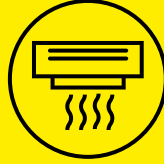

MARINE
AIR CONDITIONING

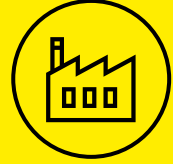

LIGHT INDUSTRY

Quality and reliability

WORLD-CLASS COILS FOR CUSTOMIZED SOLUTIONS

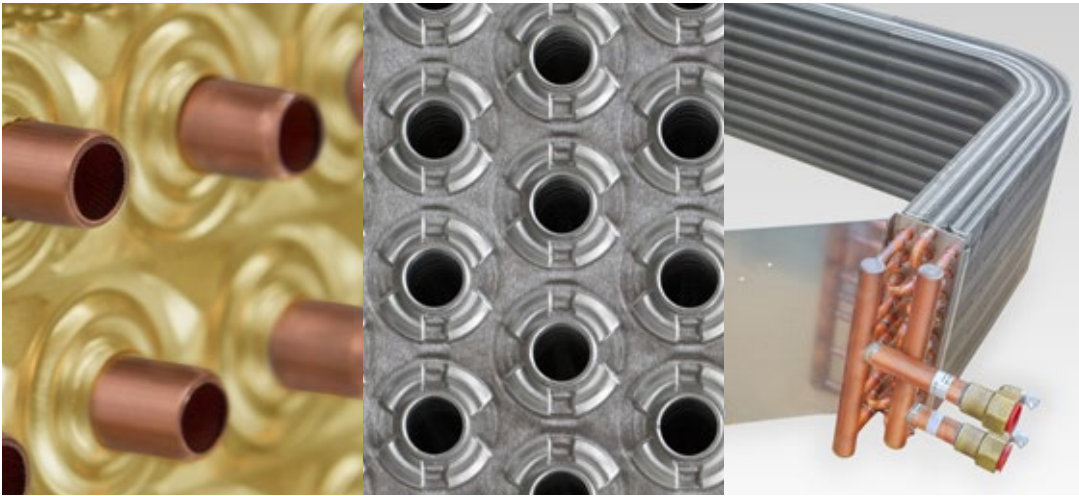

At Kelvion, we understand the importance of providing individually-designed solutions to suit the specific purpose. Our heat exchanger coils have set the benchmark in their field for efficiency, robustness and cost-effectiveness.

Quality is at the forefront of everything we do from selecting materials and components to manufacturing. Together these ensure excellent operation of our products, a long performance life and, ultimately, satisfaction for our customers.

Kelvion coils are all made with copper tubes and aluminum or copper fins and can be configured to suit specific applications and requirements. Special profiles on the fins boost their heat transfer capabilities, while keeping pressure drop

at a moderate level. Collars allow for customized fin spacing, as well as providing the contact between the fin block and the tubes. Mechanical expansion of the tubes guarantees a perfect bond between the fins and tubes for maximum heat transfer between the two process mediums – the gas and the working fluid. Several tubes are interconnected via brazed return bends to form the coil circuits, which receive the working fluid via brazed tubular headers.

The thermo- dynamic design is created with our in-house developed selection software, based on the measurements in our laboratory, which conform to DIN EN1216. All our coils are subject to rigorous testing to maintain their thermal performance.

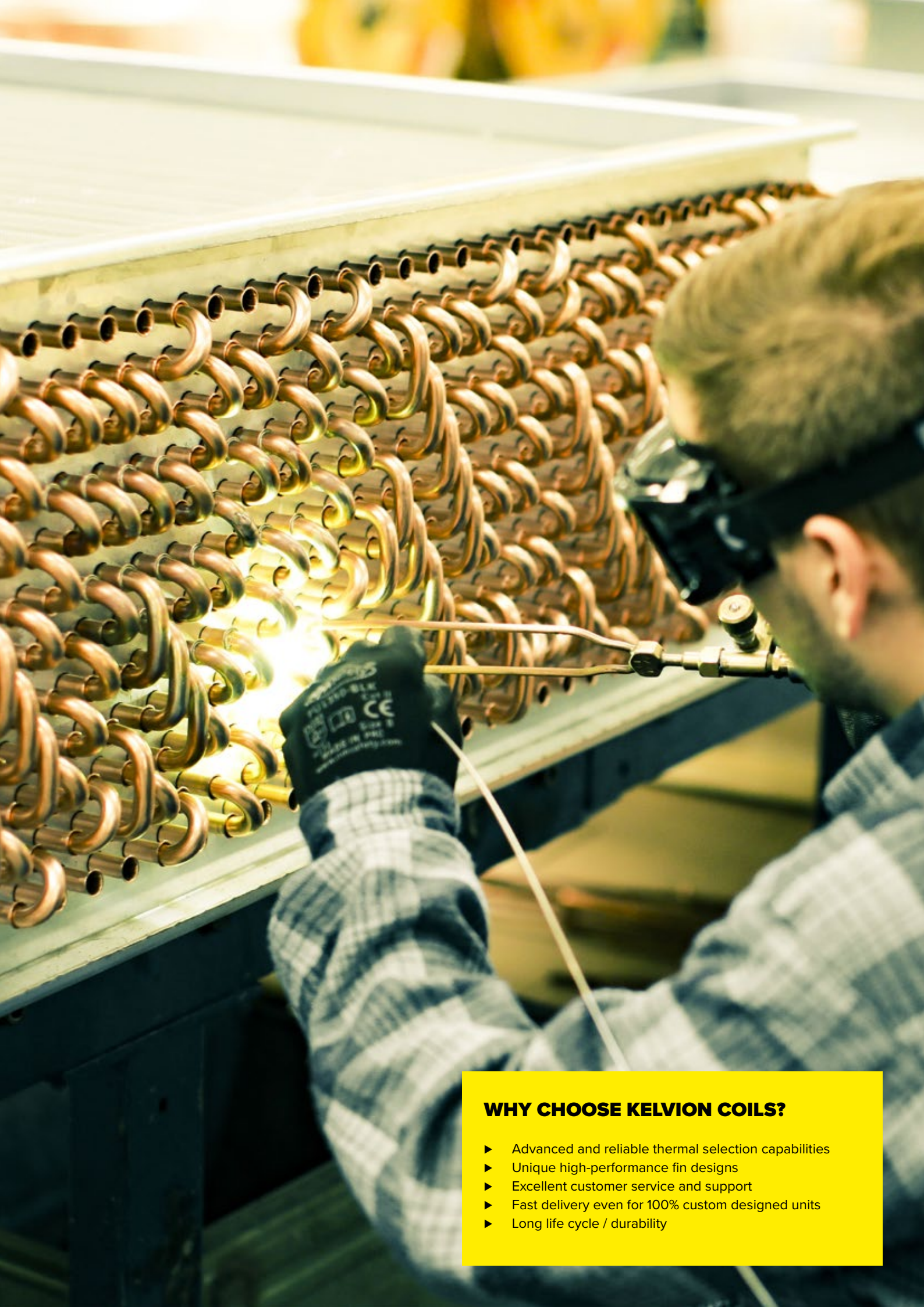

WHY CHOOSE KELVION COILS?

- ▶ Advanced and reliable thermal selection capabilities
- ▶ Unique high-performance fin designs
- ▶ Excellent customer service and support
- ▶ Fast delivery even for 100% custom designed units
- ▶ Long life cycle / durability

Overview of our coil types

RELIABLE OPERATING PARTNERS



Heat exchange systems need to comply with operational demands and run efficiently. Our coil heat exchangers meet these challenges and are reliable, robust and cost-effective.

Air heater

The heating medium within the tubes transfers the heat to the tubes and fins and finally to the cold, ambient air. Our air heaters are ideally suited for HVAC systems or for drying products with hot dry air.



Air cooler

Kelvion air coolers are designed for air conditioning and where there is a need to dehumidify the air. Hot air passes the fins, transferring heat to the tubes containing the coolant. With the temperature falling below the dew point, moisture is also removed from the air.



Run around coil

With the high efficiency run around coil design, one air cooler is positioned in a warm air stream and another in a cold air stream. Closed circuit piping connects the two units and the working medium is pumped between them. This system offers high energy recovery rates and low air

side pressure drop. It can be used for heat recovery in the winter or cooling energy recovery in the summer. It is the only suitable system where mixing exhaust air and supply air should be avoided, or if both channels are located separately, for example, exhaust air on the building's roof and supply air in the cellar (in the event of space issues).



Condenser

Our air cooled condensers are perfect partners for removing waste heat from water chillers during the summer and for using the heat from heat pumps during the winter months.



DX Evaporator

Hot air passes the fins of the evaporator and the heat is transferred to the cold refrigerant within the tubes, which then evaporates. This equipment is suited to heat pumps for heating in winter and cooling in summer.



Multi-sectional coil

Our multi-sectional coil enables one heat exchanger to serve more than one refrigerant circuit simultaneously. Each circuit can be controlled separately, such as for part load purposes. Multi-sectioning is suitable with all kinds of units listed above.

Heat pipe

The heat pipe transfers heat from a warm air stream to a cold air stream. Its simple, almost no maintenance design makes it a good and cost effective choice for all kinds of heat recovery.



Reversible coil

The specially-designed reversible coil can be used in “both directions”, as a condenser or evaporator to provide heating or cooling, depending on the season.

Round / square coil

Coils can be configured in a square or circle to fit very compact units e.g. cassette type fan coil units.

APPLICABLE MEDIA

- ▶ Water
- ▶ Water-glycol
- ▶ Thermal oil

APPLICABLE REFRIGERANTS

- ▶ R134a
- ▶ R404A
- ▶ R407C
- ▶ R410A
- ▶ R1234ze
- ▶ R1234yf
- ▶ R290
- ▶ R32

Further media and refrigerants on request.



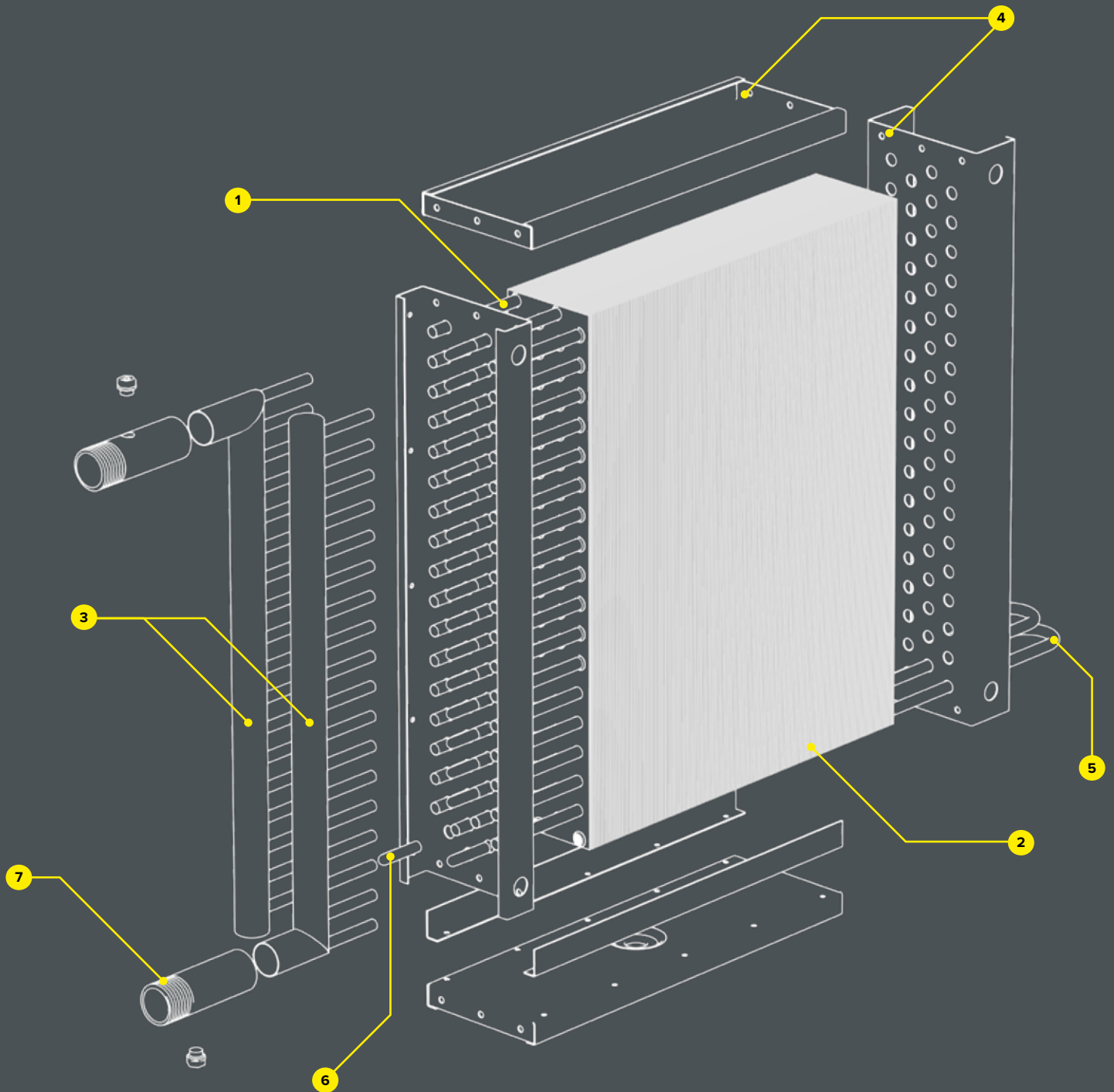

- 1 Tubes
- 2 Fins
- 3 Header tubes
- 4 Casing
- 5 Return Bends / Hairpins
- 6 Header legs
- 7 Nozzle / connection

Versatile designs

COIL COMPONENTS FOR HEAT EXCHANGE EXCELLENCE

1 Tubes

Copper tubes convey the heating or cooling medium and are available in diameters of 8mm, 10mm and 12mm as well as different wall thicknesses, to suit particular pressure requirements. With smaller tube diameters, heat exchangers can be made lighter, more compact and more cost effective. However, certain applications and working conditions may require larger tubes to handle the tube side pressure drop. Tubes can be bent to different shapes and have plain or grooved surfaces on the inside to enhance heat transfer.

2 Fins

Fins enlarge the surface and therefore counterbalance the low heat transfer on the air or gas side. Different designs influence the heat exchange performance as well as pressure losses. For 12mm tubes, you can choose fins according to your needs. Other tube diameters are combined with standardized high performance fins.

3 Header tubes

Header tubes distribute the working medium or refrigerant within the coil and their sizes are designed to suit the specific duty requirement.

4 Casing

Casings keep the tube package stable and protect the fins. Customers can choose from galvanized steel, aluminum, copper or stainless steel, depending on their application and requirements.

5 Return Bends / Hairpins

Copper return bends and hair pins connect the single tubes to circuits and ensure an efficient flow arrangement of the working medium or refrigerant within the heat exchanger.

6 Header legs

These connect the headers and tubes.

7 Nozzle / connection

This links the working medium/refrigerant-providing system. Various types are available: steel-threaded nozzles, steel flanges, brass fittings and smooth tubes for brazing on site.

Additional options

We offer a selection of coatings – Blygold and different dipping bath coatings – to guard against corrosion and aggressive media, ensuring a long operational life. Customers may also wish to incorporate drip trays, droplet eliminators, an airtight frame, space for defrost elements and transition hoods – all of which Kelvion can supply.

FIN TUBE OPTIONS

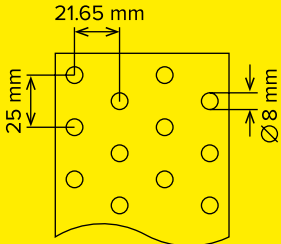
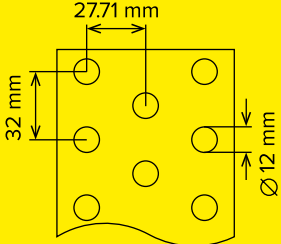
Technical specifications (further specifications on request)		
Fin tube pattern		
Tube arrangement	staggered	staggered
Tube pitch	25 mm	32 mm
Row pitch	21.65 mm	27.71 mm
Tube diameter	7.94mm	12 mm
Tube wall thickness	0.28 mm – 0.35 mm	0.35 mm – 0.8 mm
Tube inner profile	smooth, grooved	smooth, grooved
Fin thickness	0.12 – 0.18 mm	0.12 – 0.2 mm
Fin pitch	1.6 – 4.0 mm	1.8 – 4.0 (7) mm
Fin profile	uniquely waved	flat, corrugated, turbulators
Fin materials	aluminum, aluminum epoxy, copper	aluminum, AlMg2.5, aluminum epoxy, copper
Max. tube length	200 – 4000 mm	200 – 14,000 mm
Max. coil height	150– 2176 mm	128 – 2176 mm

Additional options

- ▶ Connection types: steel-threaded nozzle, steel flange, brass fittings, smooth tube for brazing on site, further types on request
- ▶ Casing designs: no casing, only side plates, complete casing, air-tight casing
- ▶ Casing materials: galvanized steel, stainless steel, aluminum, copper
- ▶ Coatings: Blygold™, Heresite™ (Säkaphen), G13-7051 (Friessen)

Application limits

- ▶ max. operation temperature: 150 °C
- ▶ max. operation pressure: 40 bar

Certificates

- ▶ ISO 9001
- ▶ PED (2014/68/UE)
- ▶ PZH (hygienic certificate HK/B/0288/02/2015)
- ▶ EAЭC N RU Д-PL.Б/108.В.03286

BETTER BY DESIGN

At Kelvion we are constantly working to make our products even better. Using computational fluid dynamics (CFD), our R&D team created an innovative, high performance design. The result is an aerodynamic gas flow between the fins leading to considerably increased heat transfer whereas the pressure drop remains at a comparable level.

This means that our coil technology can offer considerably higher performance than other products on the market.

REGULAR FIN VS KELVION FIN



REGULAR FIN DESIGN



HIGH EFFICIENT KELVION FIN DESIGN

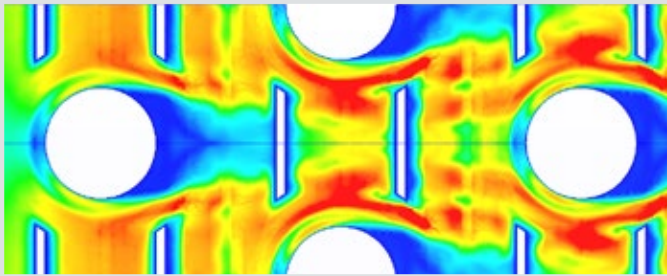

FLOW FIELDS BETWEEN FINS (CFD)

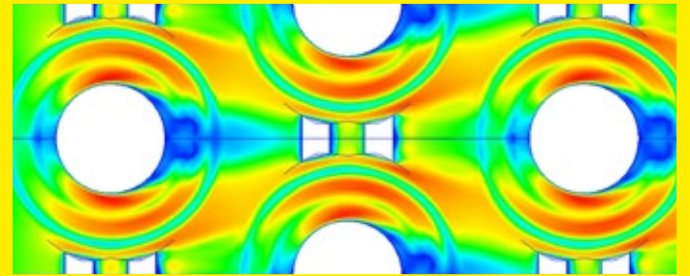

FLOW FIELDS BETWEEN FINS (CFD)



KELVION FIN - increased heat transfer at the same level of pressure drop

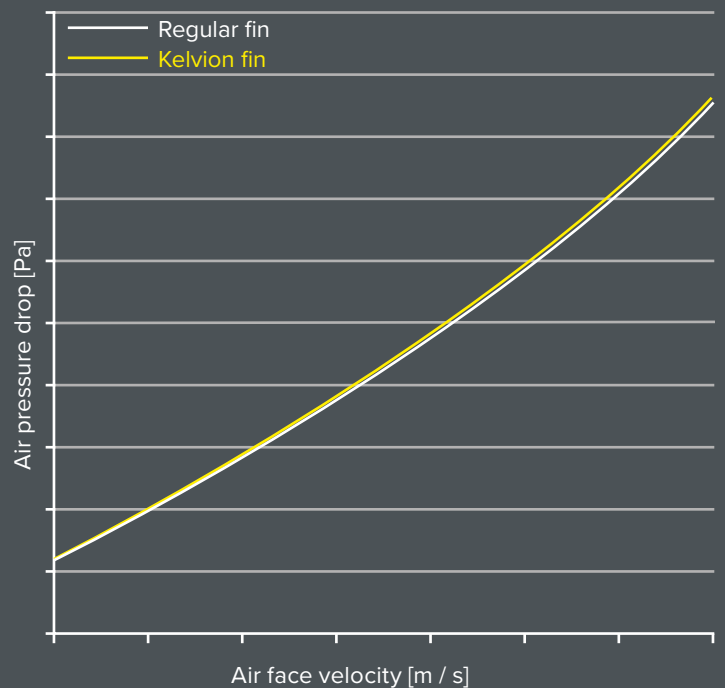
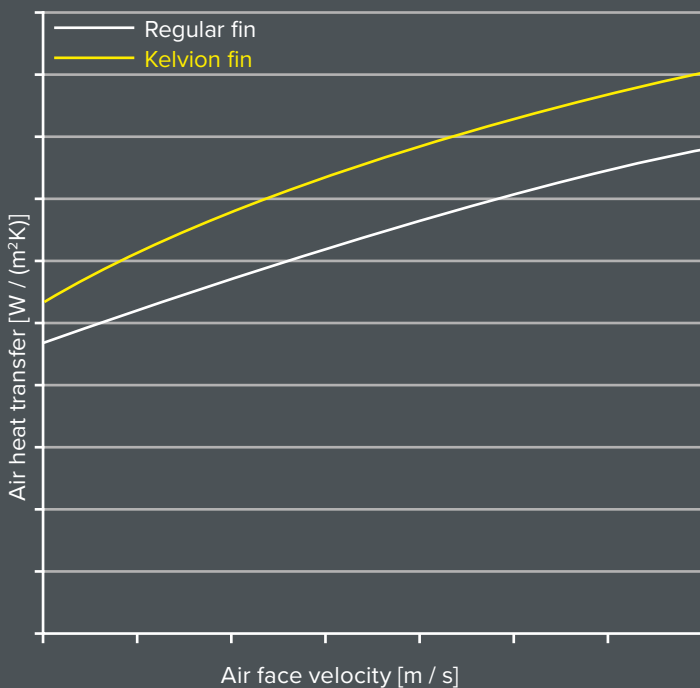



Efficient, cost-effective solutions

DESIGNED FOR YOUR **SPECIFIC** **APPLICATIONS**

Heat exchanger coils are used in a wide variety of applications involving heat transfer between a gas and a working medium or refrigerant. Kelvion's world-class coils offer unrivalled technology, backed by decades of research and engineering expertise in providing innovative, customized solutions that meet the highest standards of quality and reliability.

Our extensive coils portfolio, designed for HVAC systems, refrigeration units and various industrial processes with moderate temperatures $<150^{\circ}\text{C}$, includes a wide range of tube diameters, fin profiles and materials. Wherever our coils are installed, from air heaters and air coolers to condensers and evaporators, we can customize them to suit your requirements.

As world leaders in heat exchange technology, we take immense pride in providing robust precision-engineered solutions, manufactured to the highest quality standards, ensuring continuous and flawless operation. Using our in-depth know-how and advanced in-house thermal software, we advise on the best solutions for achieving optimal thermal properties. Unique fin designs, developed by our R&D department, enhance heat transfer, while maintaining a moderate level pressure drop.

With Kelvion, you can count on fast delivery and excellent customer support and advice from design concept to delivery of the completed unit. Also, because our products are built to last, a long life cycle is assured, giving you peace of mind.



Meeting market needs

Governments around the world have introduced regulations specifically designed to encourage the take-up of HVAC systems that comply with industry trends for saving energy. The drive towards sustainability is increasing demand for larger HVAC units that use less energy due to their increased sizes and therefore lower air velocities. Our units help customers save on energy by providing higher heat exchange performance at moderate pressure drop.

Improving the energy efficiency of commercial and industrial refrigeration equipment is also key to lower operating costs. We understand these and other challenges that our customers face. Our extensive know-how and expertise enables us to offer solutions that enable them to meet these challenges head on.

TYPICAL APPLICATIONS

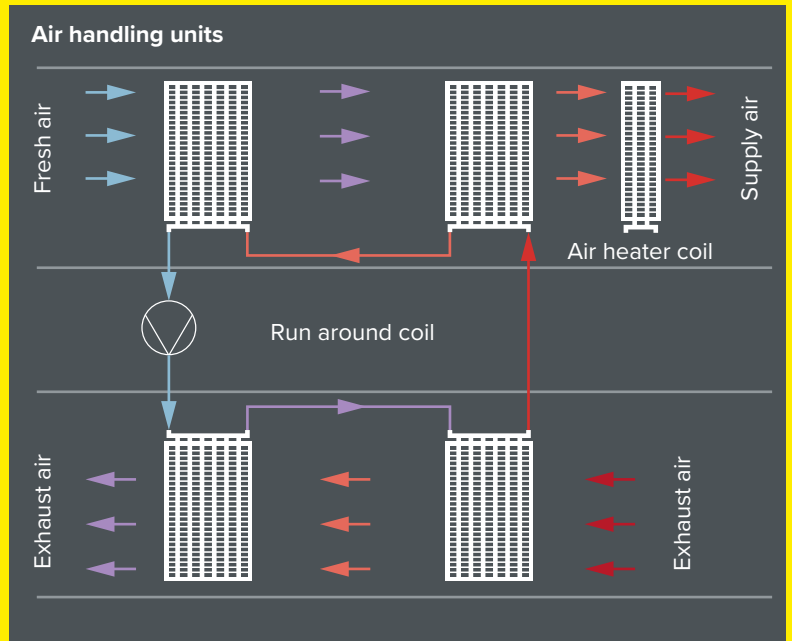
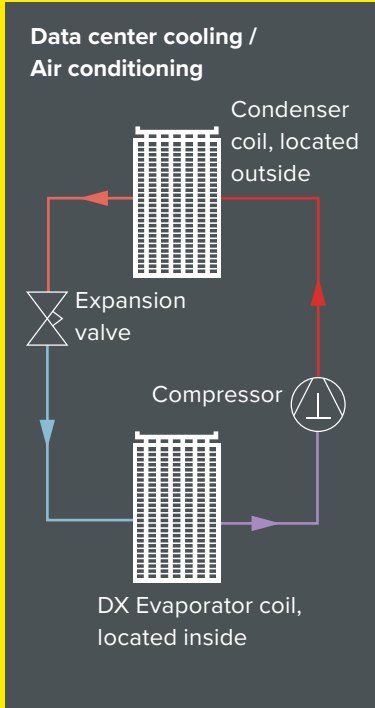

Inner pool area dehumidification

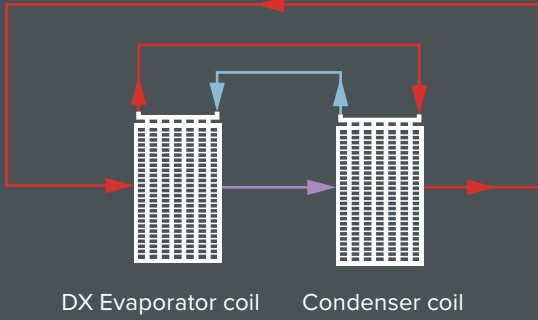

Applications for heat exchanger coils range from heat recovery and process heating to cooling, condensing and evaporating. They are suitable for air handling units, fan coil units, data center cooling, air drying systems, chillers, heat pumps, process water cooling, chilled beams, engine cooling, medical equipment, mining, gas turbine air pre-heating, energy recovery and much more.

Fan coil units

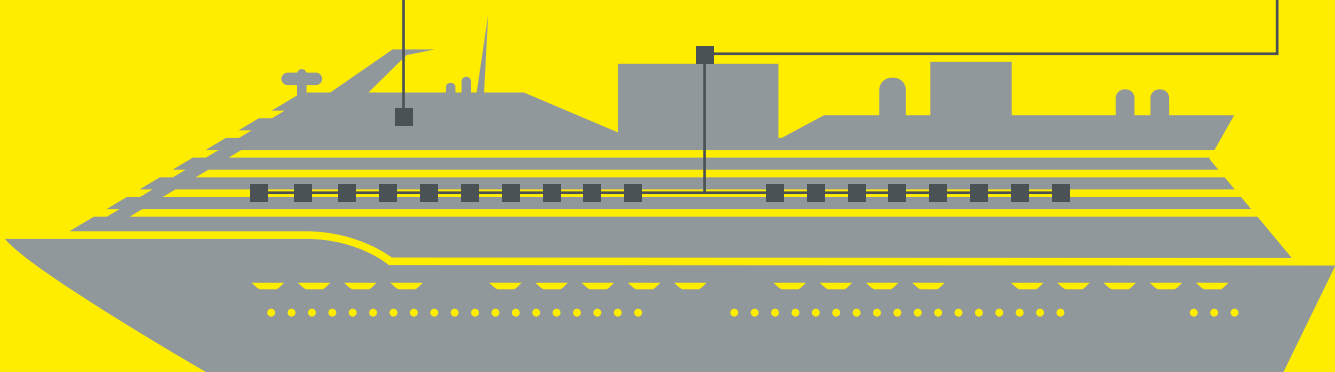
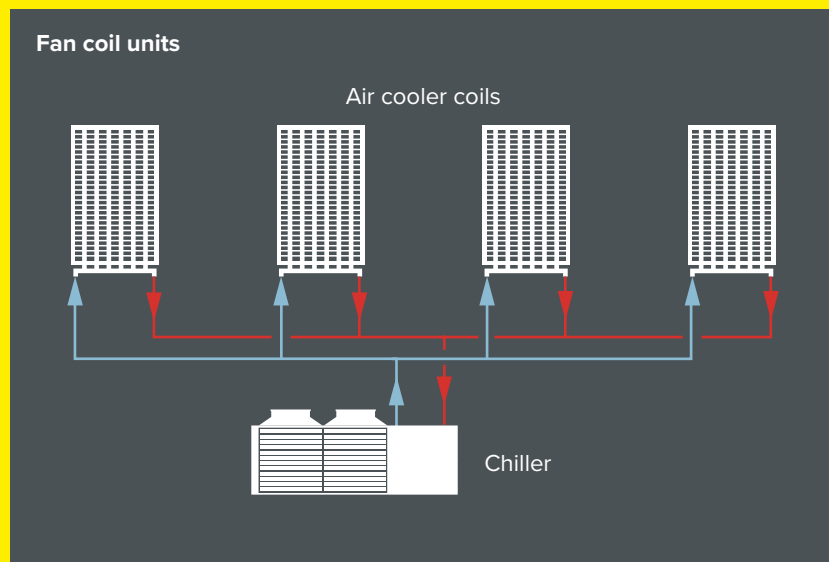

FURTHER APPLICATIONS

FOIL PRODUCTION

After production, foil is coiled on rolls. To ease this process, the film is heated and therefore expanded at the end of the production process. At hot ambient temperatures, the film has to be cooled to prevent damage. Both, heating and cooling can be successfully done by the use of heat exchanger coils and water or water-glycol as heating or cooling medium.

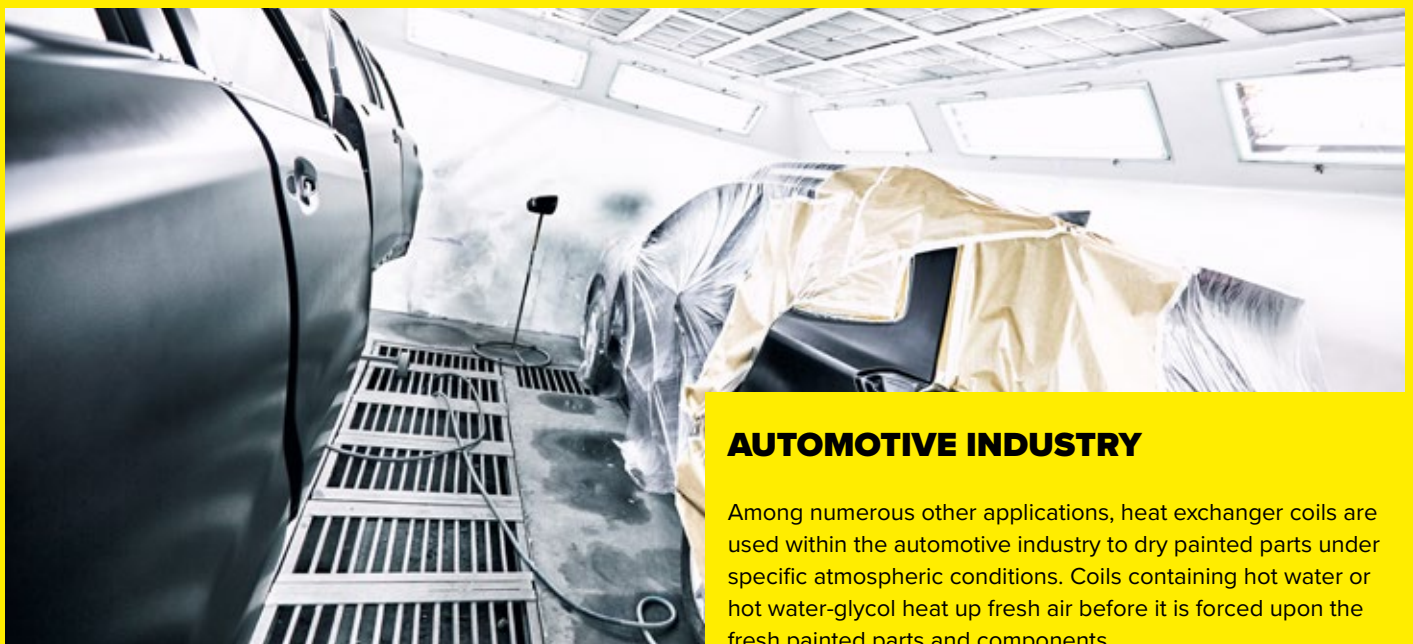
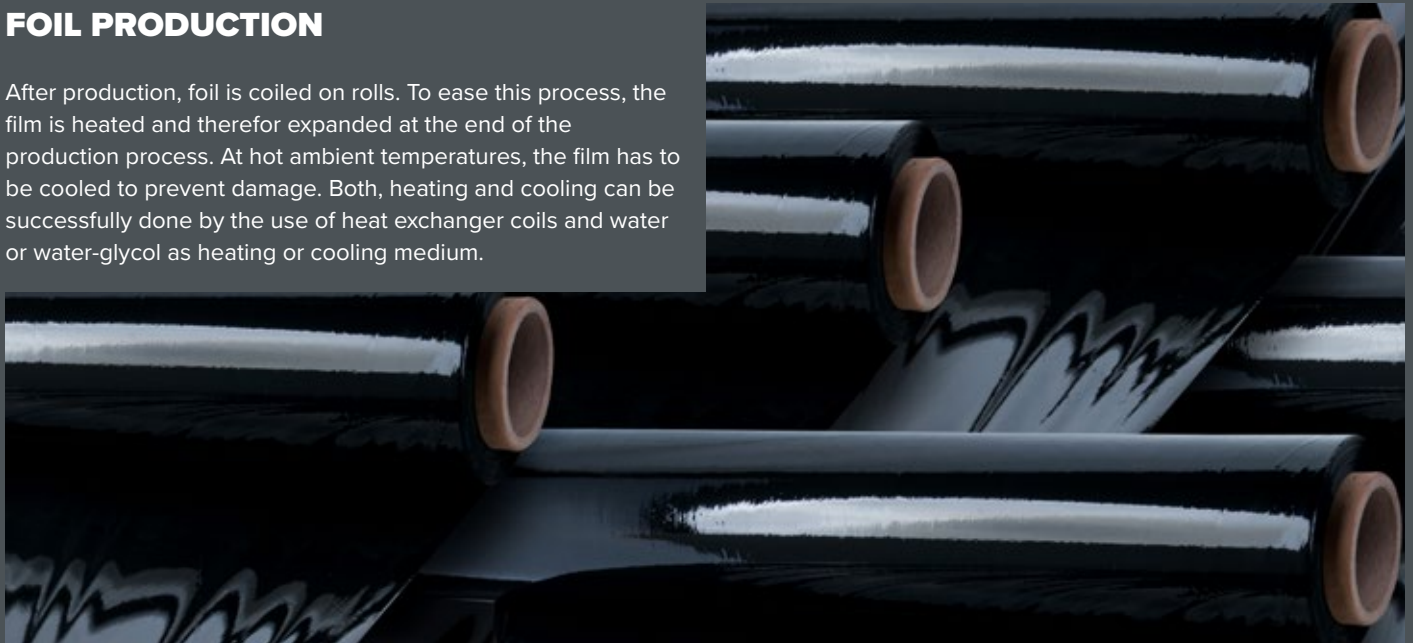

AUTOMOTIVE INDUSTRY

Among numerous other applications, heat exchanger coils are used within the automotive industry to dry painted parts under specific atmospheric conditions. Coils containing hot water or hot water-glycol heat up fresh air before it is forced upon the fresh painted parts and components.

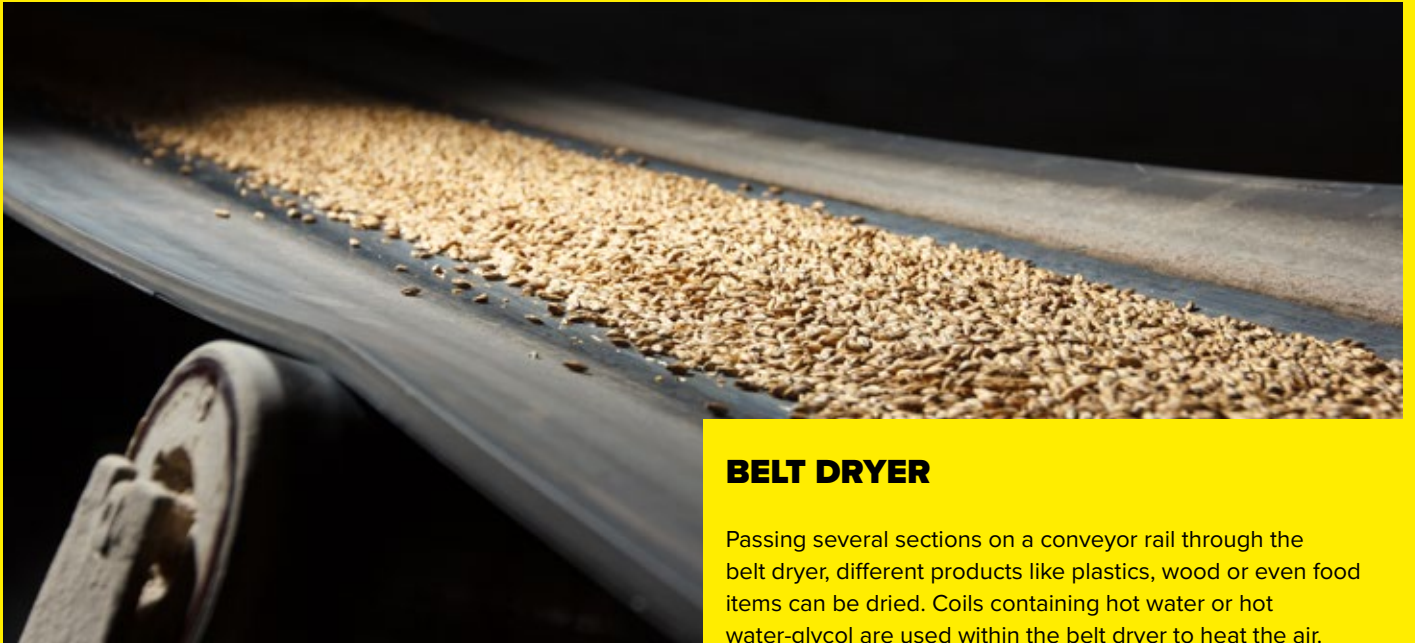

BELT DRYER

Passing several sections on a conveyor rail through the belt dryer, different products like plastics, wood or even food items can be dried. Coils containing hot water or hot water-glycol are used within the belt dryer to heat the air.

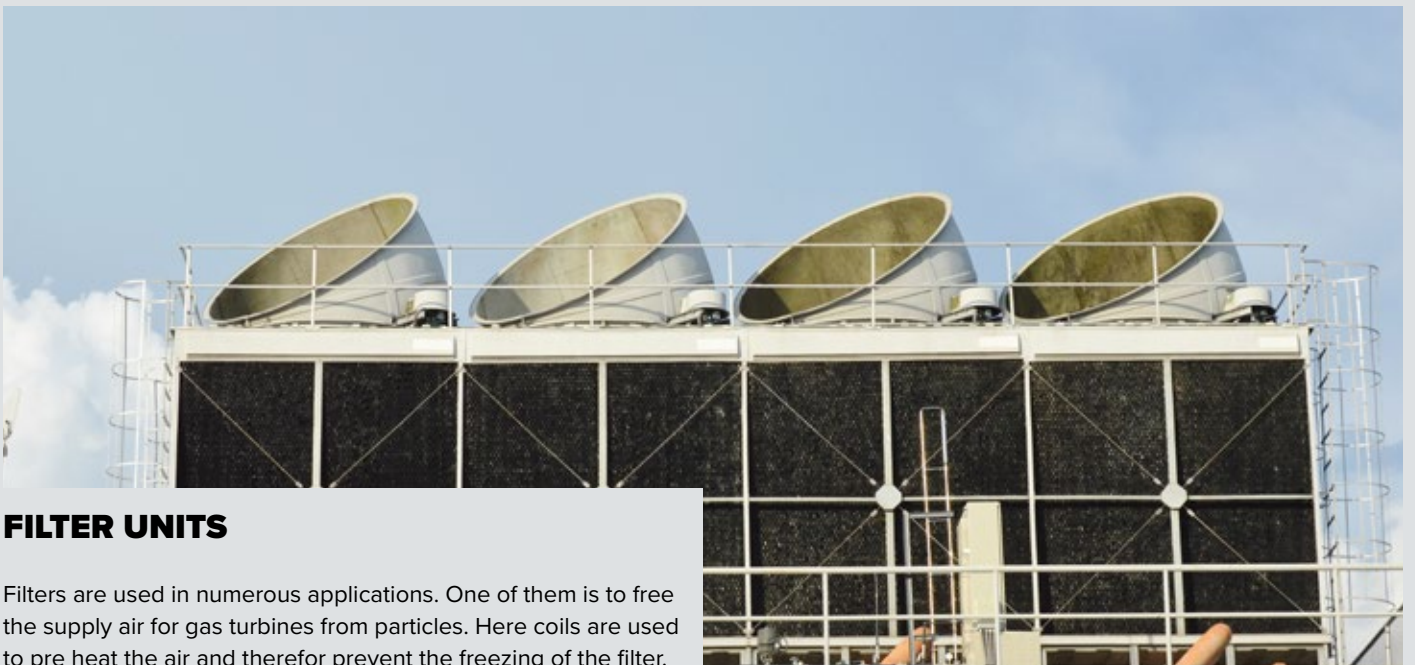

FILTER UNITS

Filters are used in numerous applications. One of them is to free the supply air for gas turbines from particles. Here coils are used to pre heat the air and therefore prevent the freezing of the filter.



PAPER INDUSTRY

Coils are used for air preheating in order to dry the paper. This application is very similar to the belt dryer, so the heating medium is water or water-glycol.



OUR SERVICE IN THREE WORDS: **PEACE OF MIND**

ALL BRAND SERVICE

Besides being experts in our own products and our former brand, we also have the expertise to service other brands.

PERFORMANCE AGREEMENTS

Performance Agreements are individually tailored service solutions that can include any of the services in our extensive service portfolio. Based on your specific needs, they maximize your return on investment, ensure continual performance excellence and make budgeting simpler.



START-UP SERVICES & ONSITE SERVICES

We ensure that our products are delivered safely and are fully validated to give a robust and reliable performance over as long a life cycle as possible. And should you encounter a problem with your equipment after it is fully commissioned, our team of experienced Field Service technicians is at your disposal to come to your site to investigate and correct any malfunctions.



REPAIRS, OVERHAULS & MAINTENANCE

Unscheduled downtime can be disastrous. That is why our trained engineers are ready to respond quickly in case of an emergency, and review and repair components while keeping any disruption to your production to a minimum. Any overhaul work is carried out quality-oriented in our service centers or on your site with the supervision of our qualified staff. Regular inspections and maintenance help to reduce costs, extend the lifetime of your Kelvion products and achieve reliable performance.



SPARE PARTS AND SPARE PARTS SOLUTIONS

Even the best equipment shows signs of wear over time. We use only the highest quality spare parts, designed to match the excellence of the originals. This ensures that the optimum interaction between components is maintained. By safeguarding the original design, we offer maximum security of your investment.

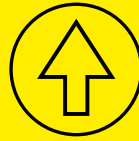

UPGRADES AND REPLACEMENTS

We replace components to keep our heat exchangers running smoothly and to prevent downtime. Where parts or components have become obsolete due to age, we will suggest a suitable upgrade. In these cases, we can often also suggest new, state-of-the-art technology which additionally enhances the performance and reliability of your process.



MONITORING, CONSULTING & TRAINING

Knowledge of the equipment's condition allows you to secure reliable production, improve safety and energy efficiency, increase equipment lifetime and prevent breakdowns. We offer consultancy services that take into account the special features of your process, making use of our profound design knowledge of heat exchange equipment. And we work closely with you to develop the exact solution that is best tailored to your needs.

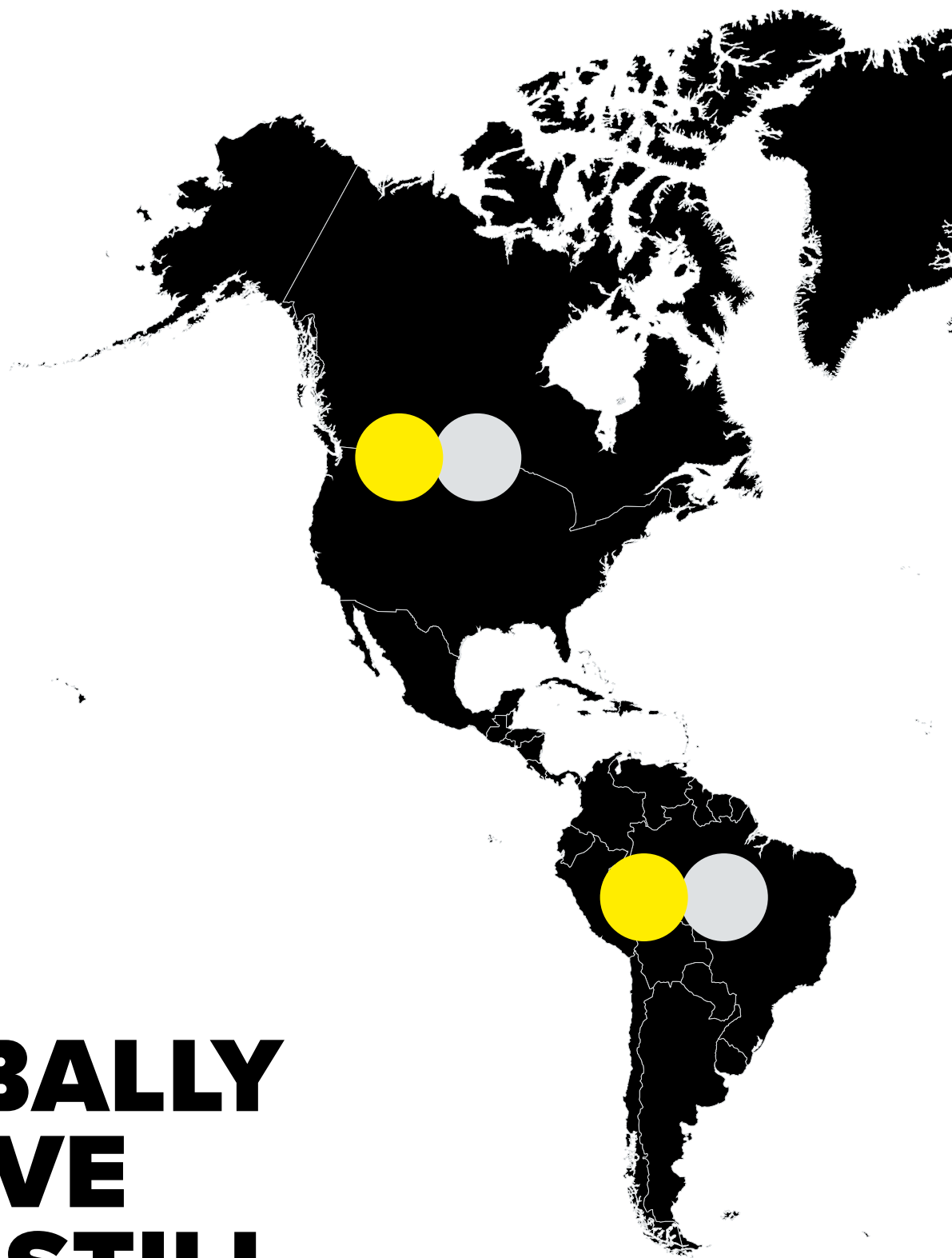

GLOBALLY ACTIVE AND STILL CLOSE BY

No matter where your market is, regardless of country, we are never far away. We are always happy to answer any questions you may have and meet your requirements. Even the largest, most successful project begins with an initial, profitable conversation. We look forward to hearing from you.

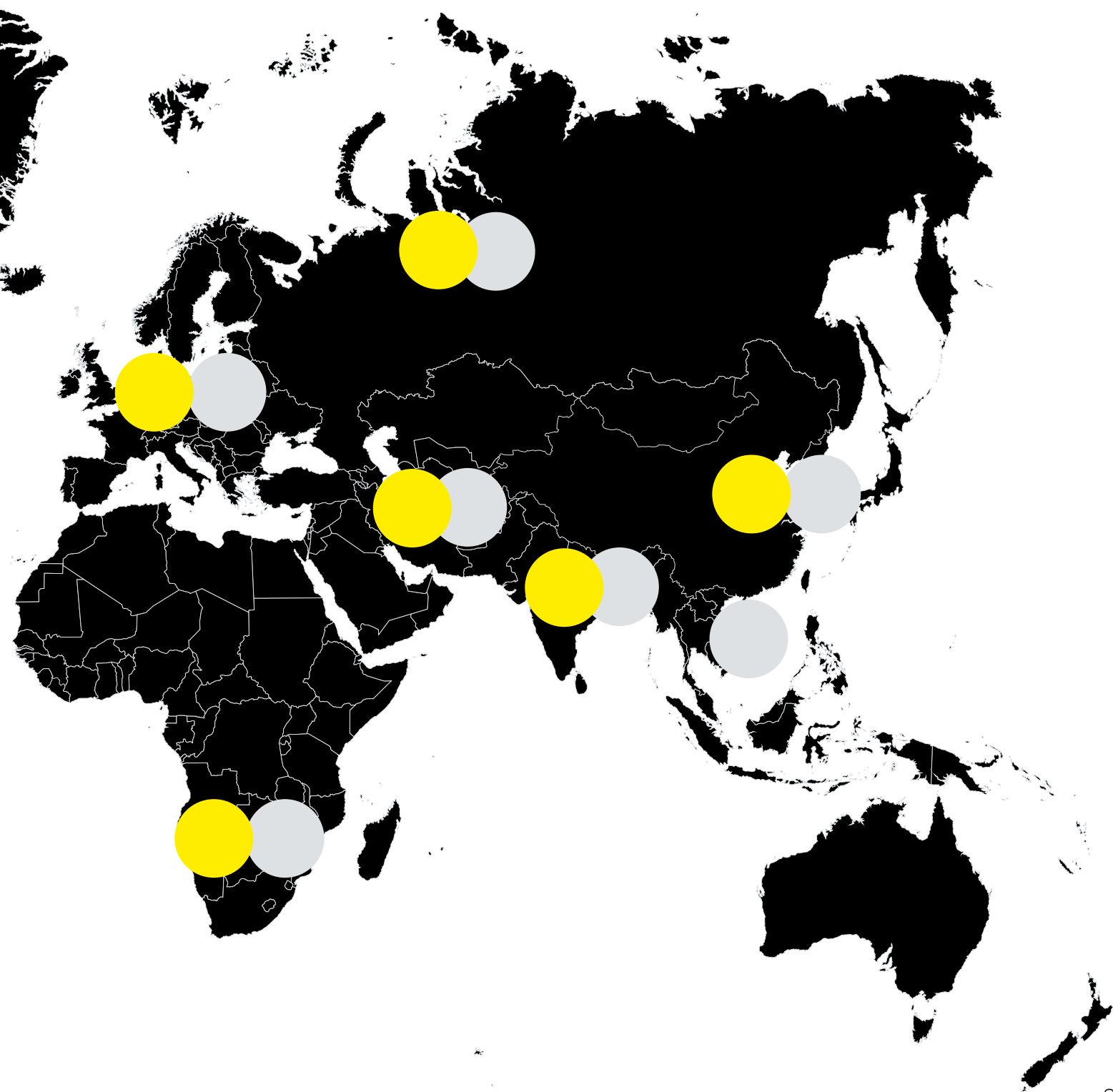

-  **Global production footprint**
-  **Global sales and service**



Just scan this QR code with your smartphone or visit our website at: www.kelvion.com – there you will find a highly competent contact in your immediate vicinity.

www.kelvion.com